

[MXQ TV Box User Manual](#)

[Manualsum](#), simplified manuals

Table of Contents

- [MXQ TV Box User Manual](#)
 - [Package Contents](#)
 - [Connection Diagram](#)
 - [Installation Steps](#)
 - [Multi-screen Interaction](#)
 - [Multi-screen Interaction](#)
 - [Introduction](#)
 - [Preparation](#)
 - [How to Use](#)
 - [Key Features](#)

MXQ TV Box User Manual

MXQ TV Box User Manual

EV4 Mini PC Media Player User Manual

FCC id: [2BH9J-DSCS95](#)

Package Contents



Device x1

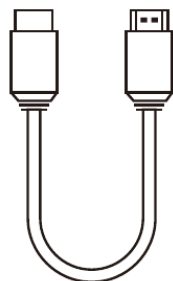

HDMI Cable x1



Remote Control x1



Power Adaptor x1

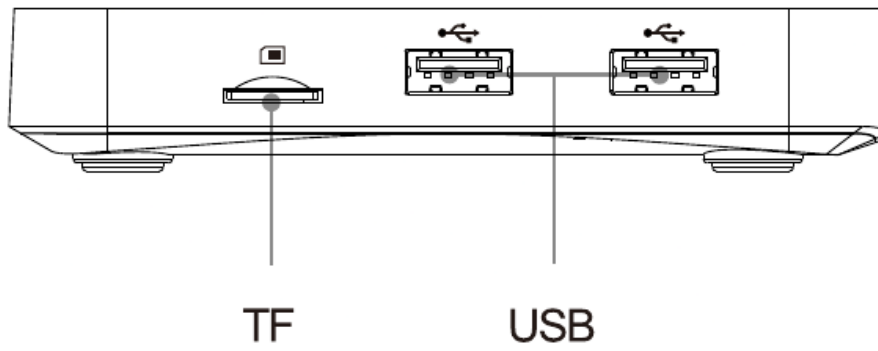
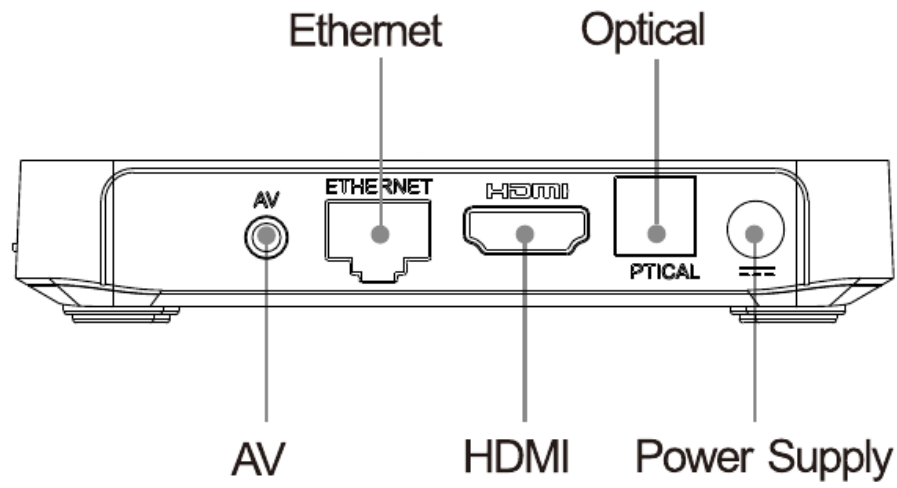

Connection Diagram

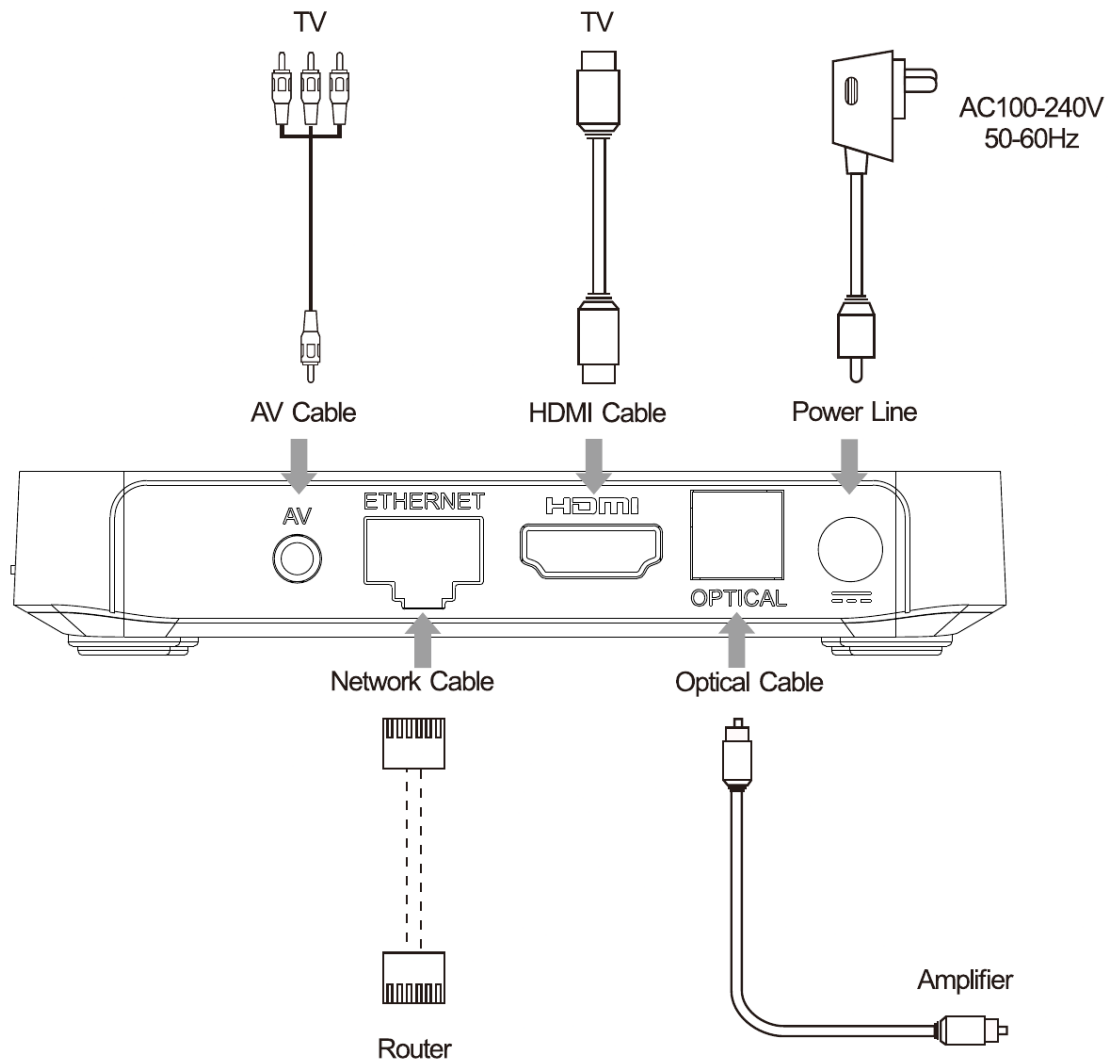

Installation Steps

1. Connect the TV Box with the power supply.
2. Connect the TV Box to your TV with an HDMI cable or AV cable.
3. For a wired connection, plug in an Ethernet cable from the TV Box to your modem or router. For wireless, choose your Wi-Fi network and input your Wi-Fi password.

Multi-screen Interaction

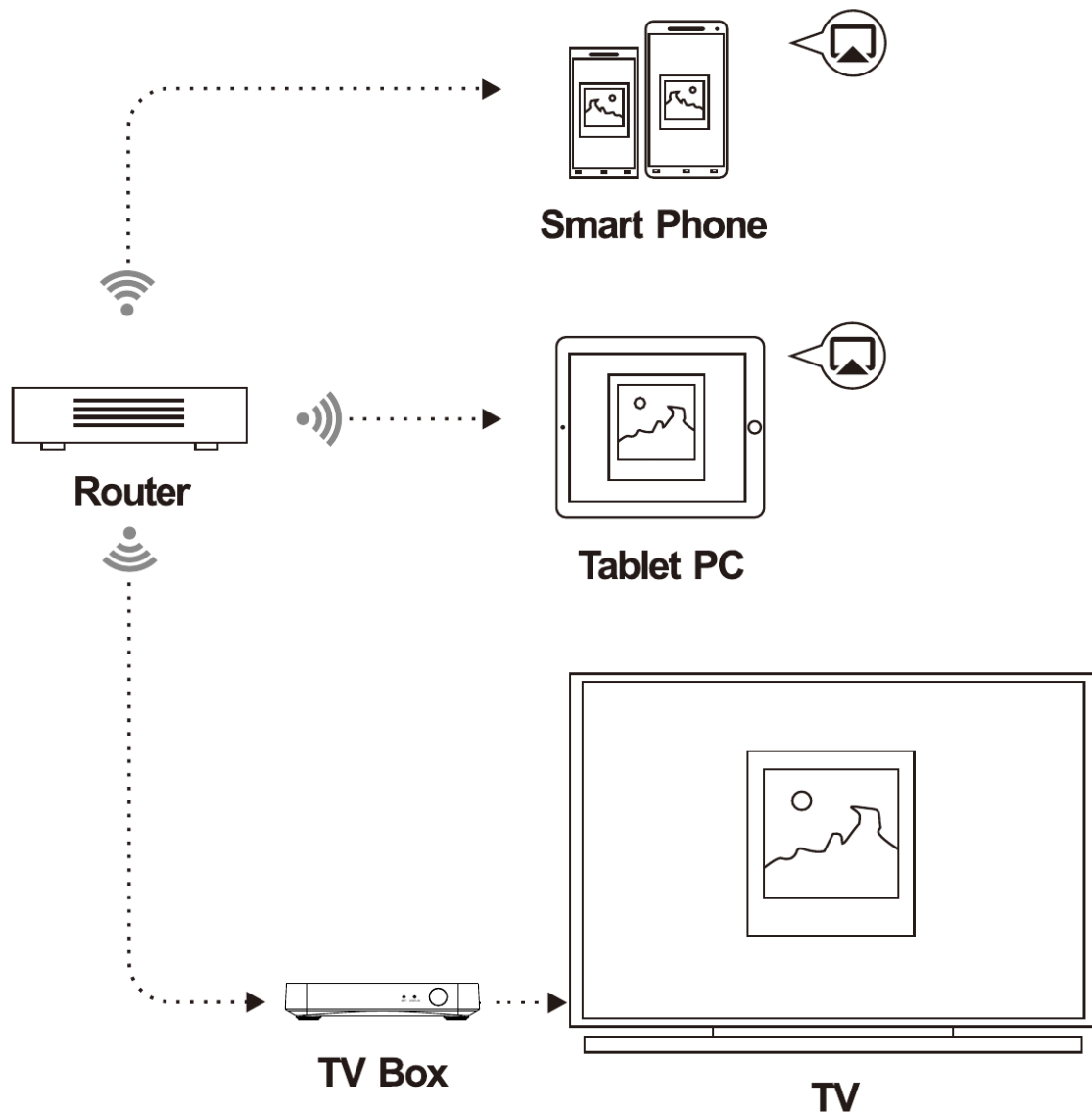

Multi-screen Interaction

Introduction

The photos, music or videos on your smart phone or tablet PC can be delivered to the TV box and be displayed on TV.

Preparation

Your device must be connected to the same network with the TV box.

Then the device can be found and be able to deliver the pictures, music or videos to the TV box.

How to Use

When the TV box is found in the same network, the logo  will appear

in the picture player, music player or the video player. The logo  will also appear in the related applications of mobile device, choose and click

the  and begin to the enjoy the sharing journey.

Key Features



Amlogic S905X3 Quad-Core ARM Cortex-A55 CPU with
ARM G31 MP2 GPU



4Kx2K@60fps



10/100/1000 M Ethernet,standard RJ45; T2R2 WiFi



Android 9.0 OS, OTA upgrade support