

# Fanvil Link Technology Portable DECT Phone User Manual 2BCUQ-W610D

## [Manualsum](#), simplified manuals

### Table of Contents

- [LINKVIL Portable DECT Phone Quick Start Guide](#)
  - [Packing list](#)
  - [Handset](#)
  - [Install the battery](#)
  - [Replacement battery](#)
  - [Connect the charging base](#)
  - [Install the belt clip](#)
  - [Connecting W610D to the Network](#)
  - [Language setting](#)
  - [Country/Region setting](#)
  - [Making a call](#)
  - [Accepting a call](#)
  - [Putting a call on hold](#)
  - [3-party conference](#)
  - [Call transfer](#)
    - ■ ■ [Attended transfer:](#)
    - [Blind transfer:](#)
  - [Call forward](#)
  - [Call Mute](#)
  - [Call list](#)
  - [Phonebook](#)
    - ■ ■ [Access phonebook:](#)
    - [Add new entry:](#)
  - [Programmable keys](#)
    - ■ ■ [DSSkey](#)
    - [PTT key](#)
  - [Redial](#)
  - [Do not disturb](#)
  - [Voice message](#)
  - [Bluetooth](#)
  - [Warning](#)

# **LINKVIL Portable DECT Phone Quick Start Guide**

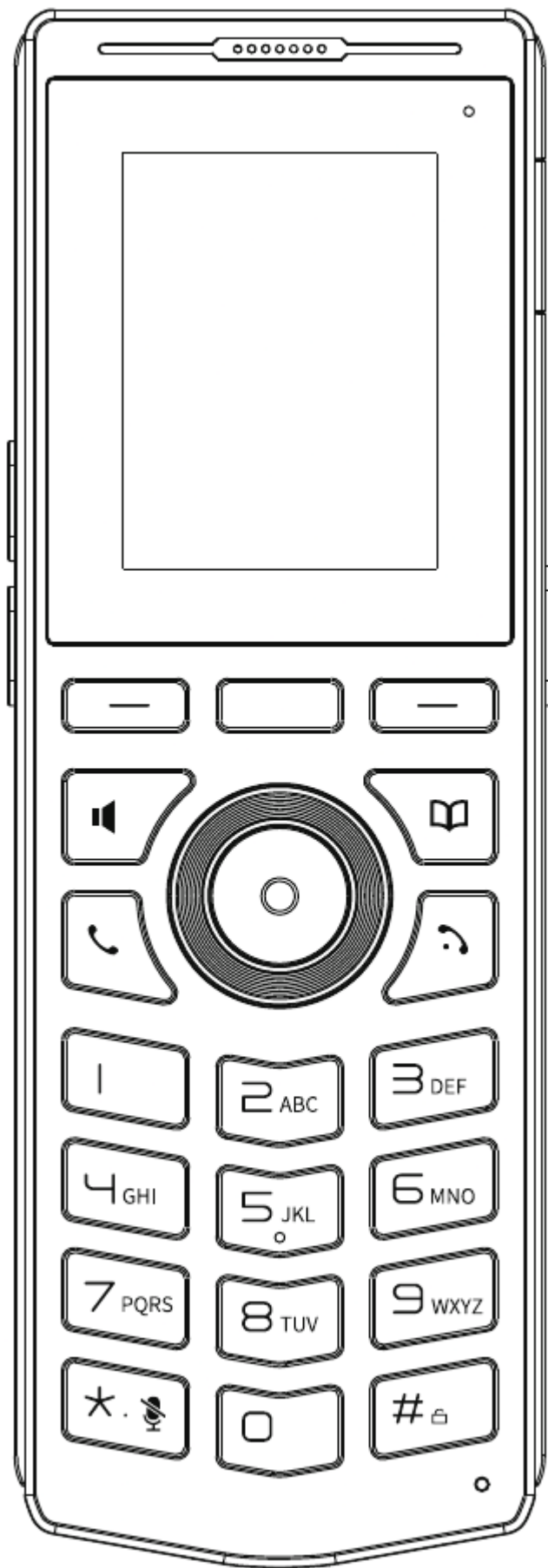

**W610D**

[Manualsum](#)

## Packing list



Portable  
dect Phone

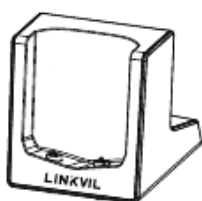

Charging Base



Quick Start Guide

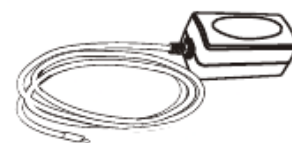

Power Adapter



Rechargeable Battery

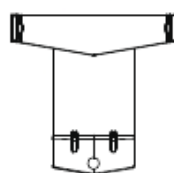

Belt Clip

## Handset

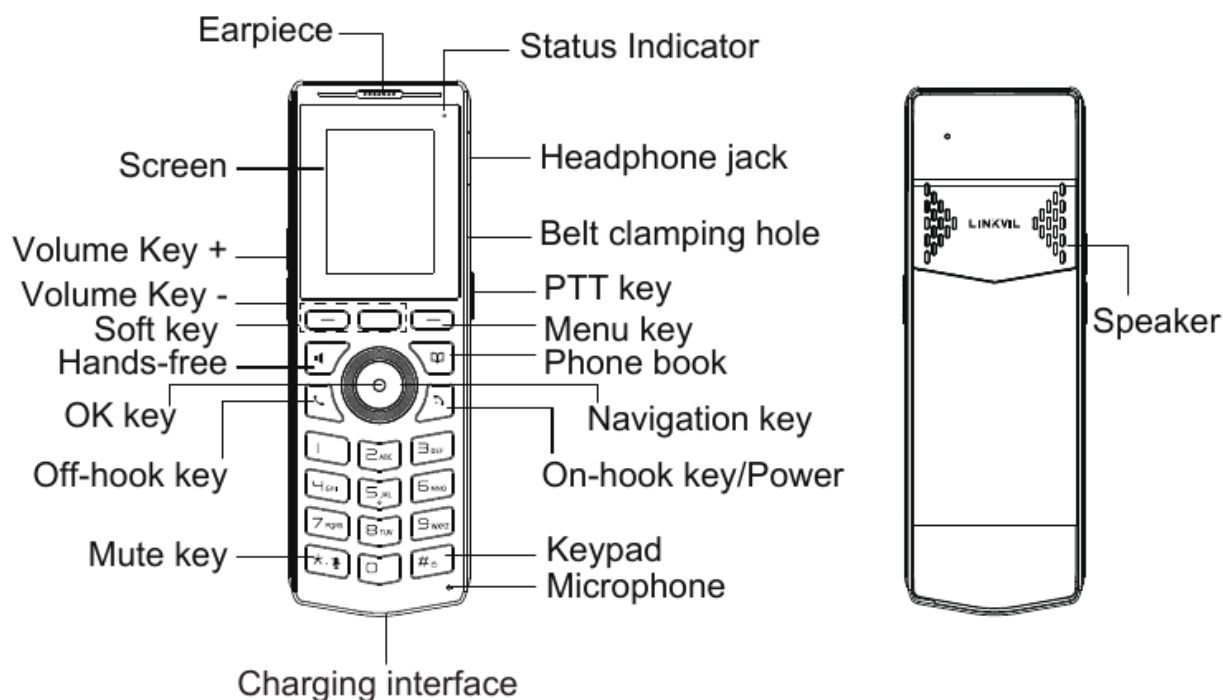

## Install the battery

1. Remove the rear case: Remove the rear case of the whole machine with a little force from the handle position A of the rear case of the main unit.

2. Install the battery: Take out the battery from the packaging box, with the battery with the notch facing up, put the battery C at the battery compartment C.
3. Install the battery cover: Align the back cover with the buckle on the back of the main unit, press your hands along the edge of the main unit from top to bottom (there will be a “click” sound during the process), and ensure that there is no gap, it means that the back cover is fastened.



Remove the rear case

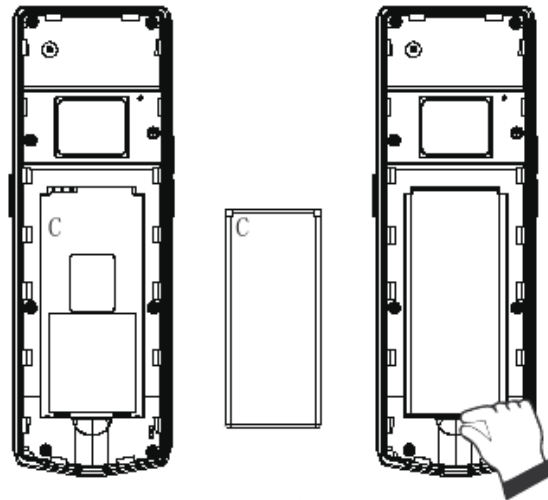

Install the battery

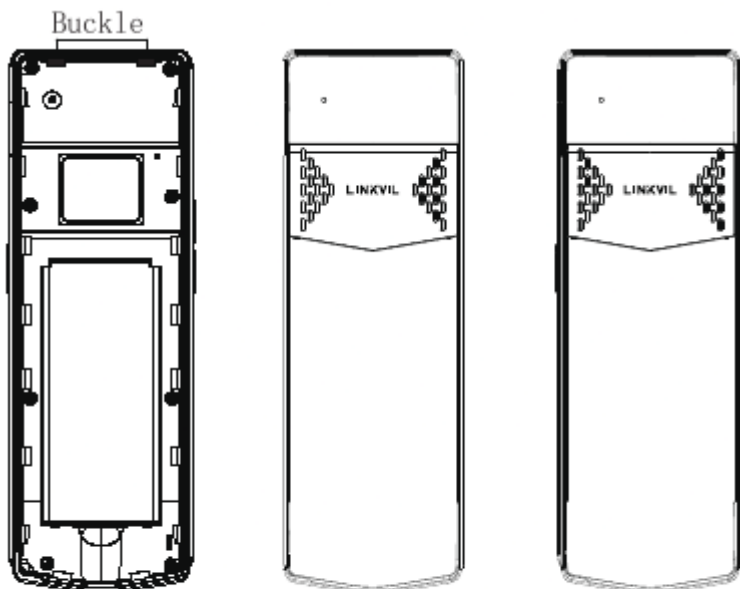

Install the back cover

# Replacement battery

1. Remove the rear case: Remove the rear case of the whole machine with a little force from the handle position A of the rear case of the main unit.
2. Remove the old battery: Push up at B to remove the old battery.
3. Install the new battery: Take out the battery from the packaging box, with the battery with the notch facing up, put the battery C at the battery compartment C.
4. Install the back cover: Align the back cover with the buckle on the back of the main unit, press your hands along the edge of the main unit from top to bottom (there will be a “click” sound during the process), and ensure that there is no gap, it means that the back cover is fastened.

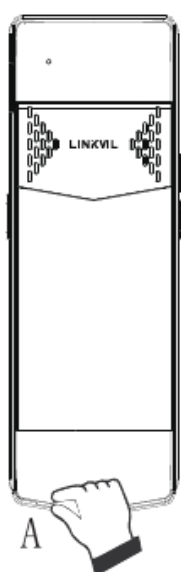

Remove the rear case

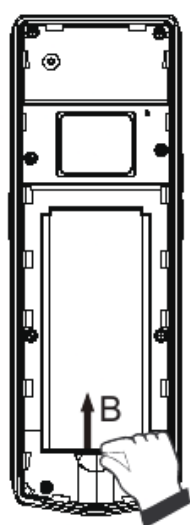

Remove the battery

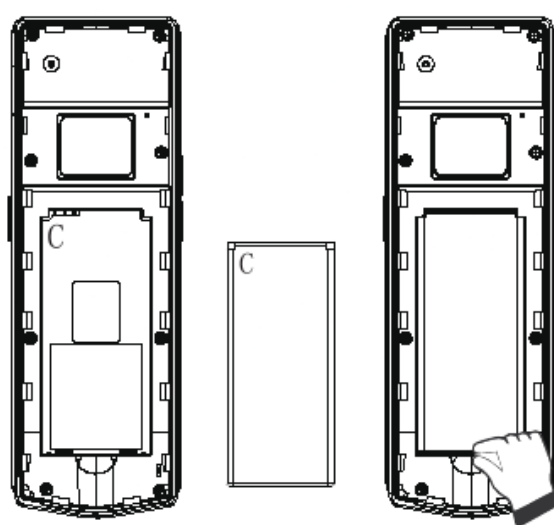

Install the battery

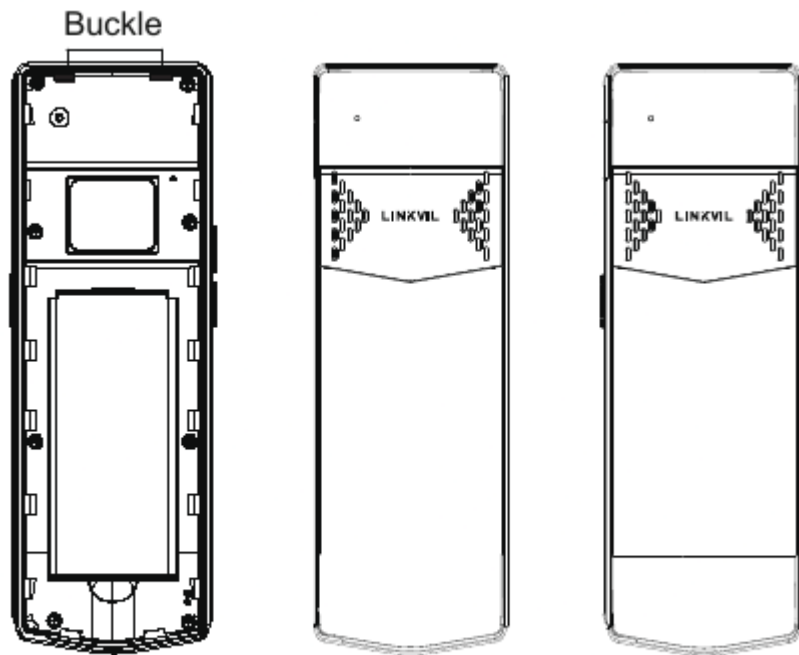

Install the back cover

## Connect the charging base

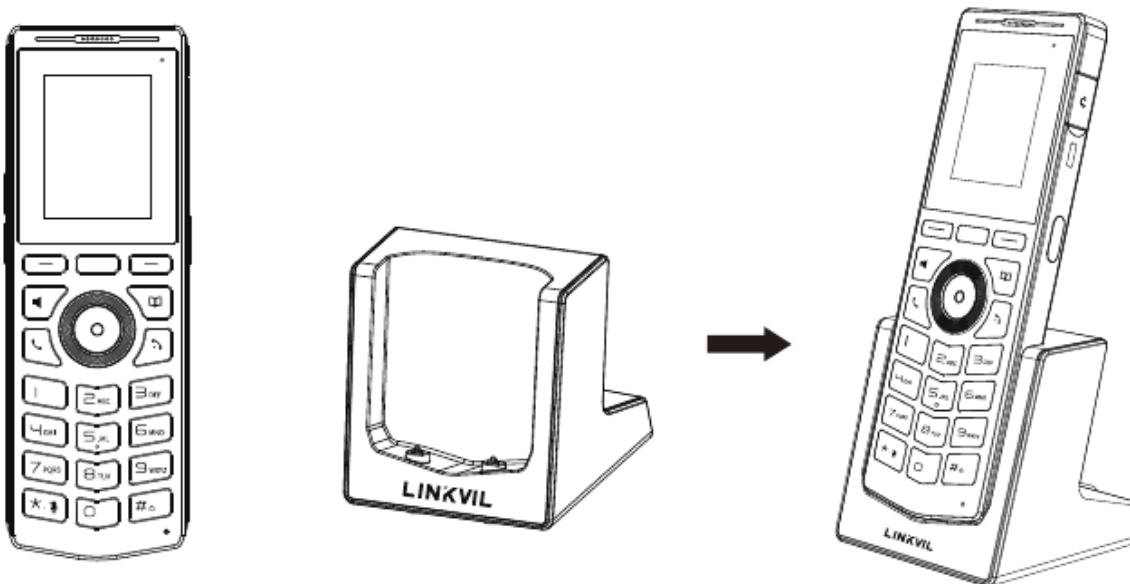

### Note:

1. Use original factory supplied power adapter (5V/2A). A third-party power adapter may damage the handset.
2. Check the charging status on the top-right corner of the LCD screen.

## Install the belt clip

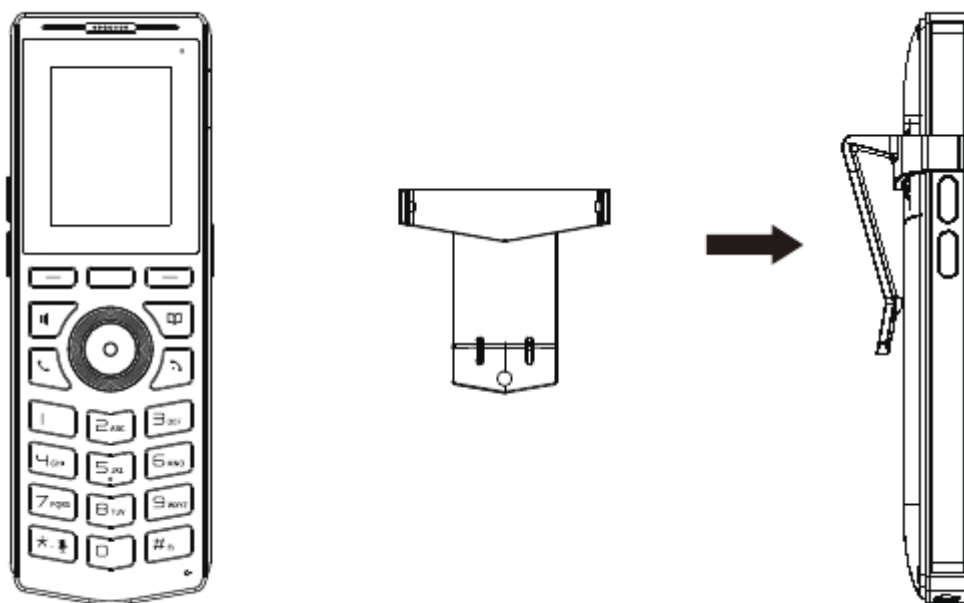

## Connecting W610D to the Network

To use the communication function of W610D, the device must first be connected to the network. The specific steps are as follows:

1. The system administrator needs to first enter the IPUI address of the device into the system on the paired Manager and authorize the device to access.
2. Terminal connects the network
3. Boot up the W610D device and select the the corresponding country, access Menu > WLAN > Available Networks. Select the Manager's RFPI, click "Connect," and enter the password to establish a successful connection.
4. After a successful connection, the terminal automatically obtains configuration settings (SIP account and internal extension) and can perform call operations.

## Language setting

1. Press Menu key > Basic > Language.
2. Select the desired language and press OK softkey.

## Country/Region setting

1. Press Menu key > Network> Country/Region.
2. Select the desired area and press OK softkey.



Note that the Country/Region of W610D and Base must be consistent so that W610D can search and connect to Base.

## Making a call

1. Pre-dialing: enter the phone number and press Handfree/Off-Hook/Softkey-Dial key.
2. Direct dialing: press Handfree/Off-Hook key and enter the phone number, then press “#’/Handfree/Off-Hook key to call out the number.
3. Headset: Insert headphones, enter the number, and press the off hook button.
4. Designated line: press Handfree/Off-Hook key, or enter the phone number directly, then press Navigation Key-Up key to select line.

## Accepting a call

1. With the handset: press the Off-Hook key.
2. With a headset: when the headphone inserted, press the Off-Hook key.
3. With the handsfree: press Handfree key.

## Putting a call on hold

1. Press the softkey-More > Hold, caller is put on hold.
2. To retrieve the call press the softkey-More > Resume.

**Note:** with more than one active call, select desired call with the navigator keys and use the corresponding softkey to hold or resume.

## 3-party conference

1. Once in line with 1st caller, press softkey-More > Conference, 1st caller is put on hold.
2. Then call the 2nd number.

After, 2nd call is established, press softkey-More >Conference to set up the conference.

## Call transfer

### Attended transfer:

1. Press softkey-More > Xfer during the active conversation, the call is put on hold.
2. Dial the second telephone number.
3. When the call is answered, then press softkey-More > Xfer to complete the operation.

### **Blind transfer:**

1. Press softkey-More > Xfer during the active conversation, the call will be on hold.
2. Then enter the 2nd telephone number and press softkey-More > Xfer.

## **Call forward**

1. Press Menu > Features > Call Forward.
2. Select the line, the type of forward, enter the destination number and status and press OK.

## **Call Mute**

1. Long Press™ " key to Mute the microphone during the call.
2. Long Press™ " key again to un-mute the conversation.

## **Call list**

1. Press Navigation keys - Up or Menu > Call Log > Local Call Logs.
2. Scroll through the list using navigation keys.
3. To dial an entry, press Softkey- Option > Dial or Handfree/Off-Hook key.

## **Phonebook**

### **Access phonebook:**

1. Press Physical buttons > PhoneBook or Menu > PhoneBook > Local Contacts.
2. Select All Contacts or other group.
3. To dial an entry, press Softkey- Option > Dial or Handfree/Off-Hook key.

### **Add new entry:**

1. Press Menu > PhoneBook > Local Contacts, Press All Contacts or other group > Press Add.
2. Enter name and number and press OK soft key.

## **Programmable keys**

### **DSSkey**

Press Navigation keys - Left or Navigation keys -Right, select among the configurable items, and select your desired type and value, press OK key.

## **PTT key**

Press the PTT key on the side of the device, select your desired type and value, press OK key.

## **Redial**

Press Handfree/Off-Hook key and then press Softkey-Redial.

## **Do not disturb**

1. Press Menu > Features > DND.
2. Select the Mode, and press OK soft key.

## **Voice message**

1. To access your voice mailbox, press Menu > Message > Voice Message, number of messages will be indicated if provided by your server or PBX.
2. Select the line and press Play to call.

## **Bluetooth**

1. Press Menu > Basic > Bluetooth
2. Press ok to enter the bluetooth open interface. After opening, press scan to display the list of bluetooth scanned. Select any device and press connect.

## **Warning**

Used below 35°C in the state of charge

1. Please dispose of lifeless battery under guidance.
2. Recycle your device.
3. Replacement of a battery with an incorrect type that can defeat a safeguard (for example, in the case of some lithium battery types).
4. Disposal of a battery into fire or a hot oven, or mechanically crushing or cutting of a battery, that can result in an explosion.
5. Leaving a battery in an extremely high temperature surrounding environment that can result in an explosion or the leakage of flammable liquid or gas.
6. A battery subjected to extremely low air pressure that may result in an explosion or the leakage of flammable liquid or gas.