

Unattended Payment Terminal Su3 User Manual

Manualsum, simplified manuals

Table of Contents

- [Unattended Payment Terminal Su3 User Manual](#)
 - [Unpacking Inspection](#)
 - [Knowing The Product](#)
 - [SAM SIM and TF card Installation](#)
 - [Maintenance and Usage](#)
 - [Maintenance and Usage](#)

Unattended Payment Terminal Su3 User Manual

Unattended Payment Terminal Su3 User Manual

Fujian Wazan Tech. Unattended Payment Terminal Su3 User Manual

([2BGEKU0301](#))

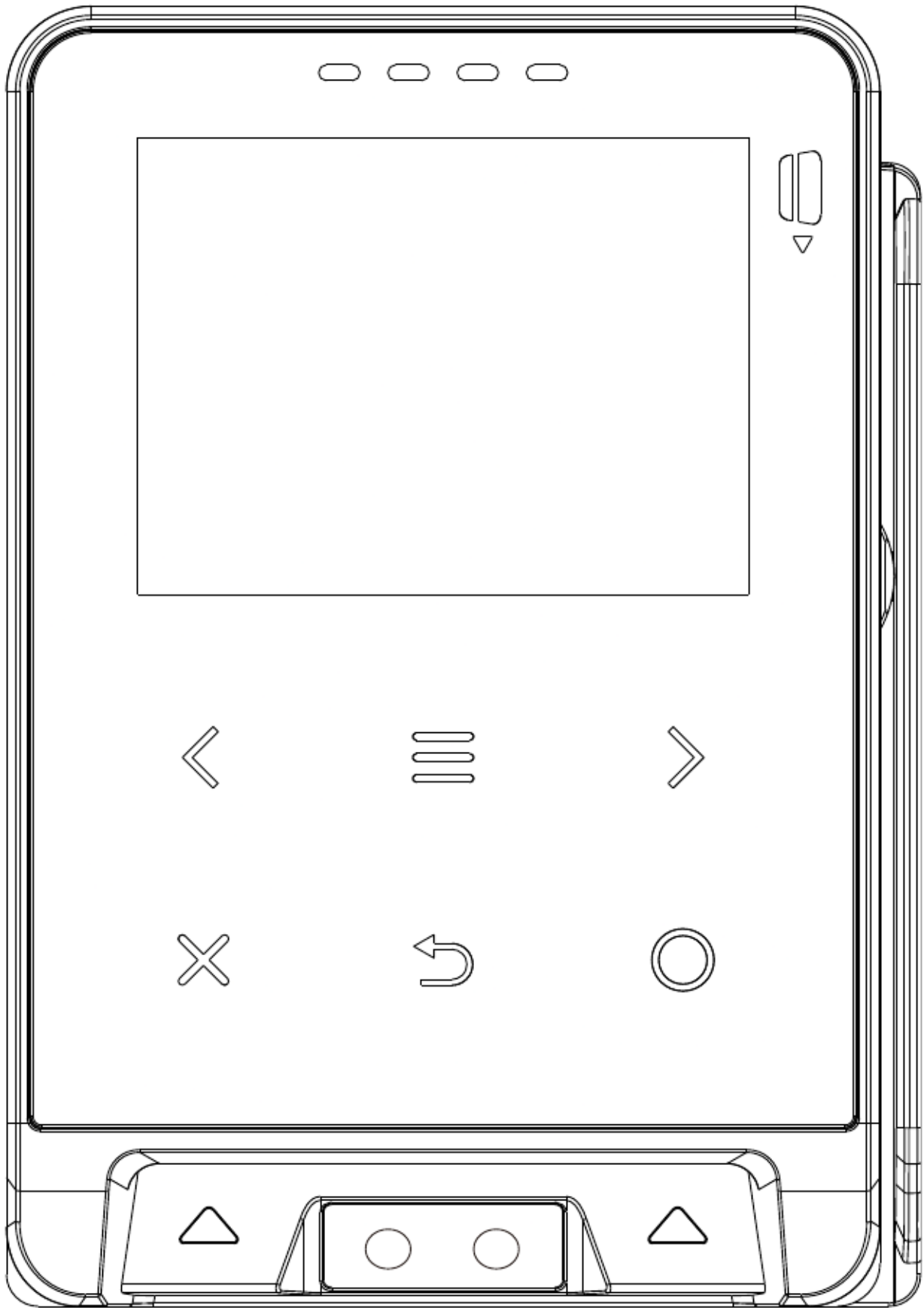

Unpacking Inspection

Please inspect all packages upon receipt. Please contact us if there's any damage or issue.

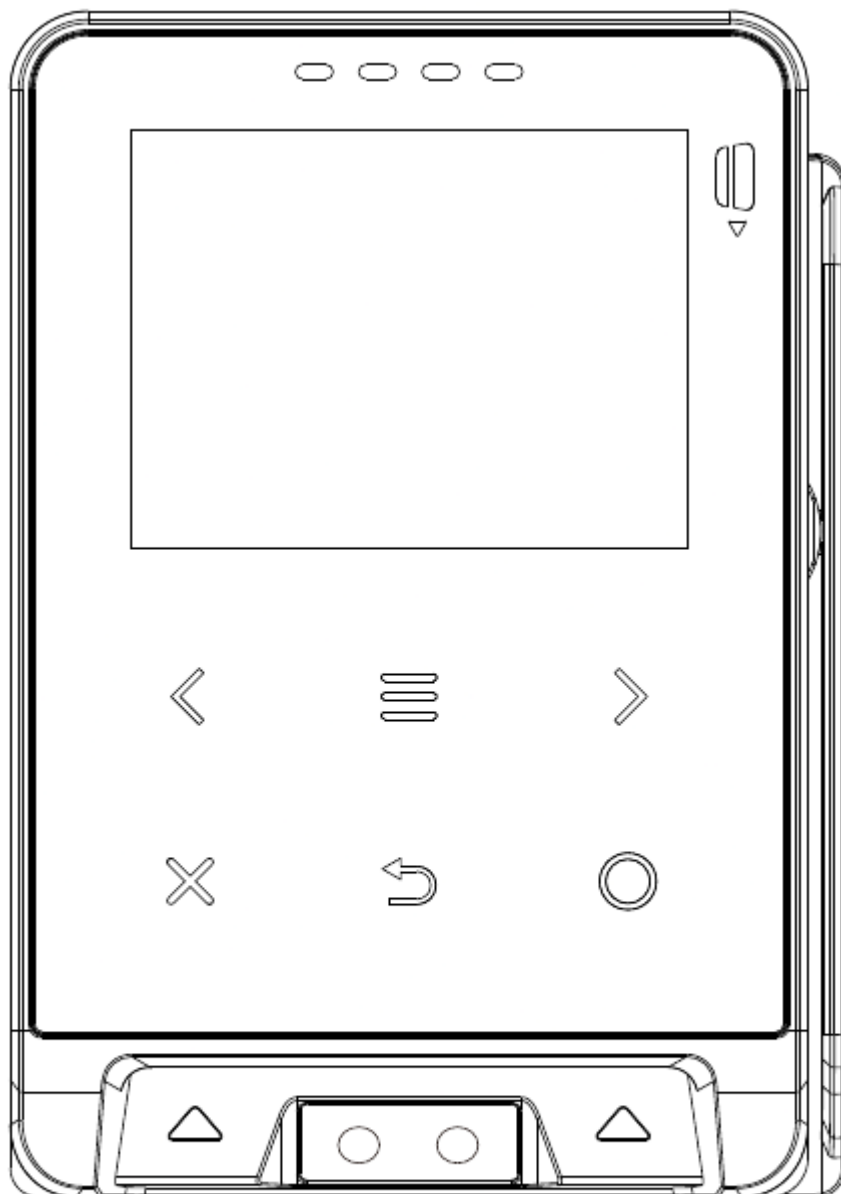

Su3

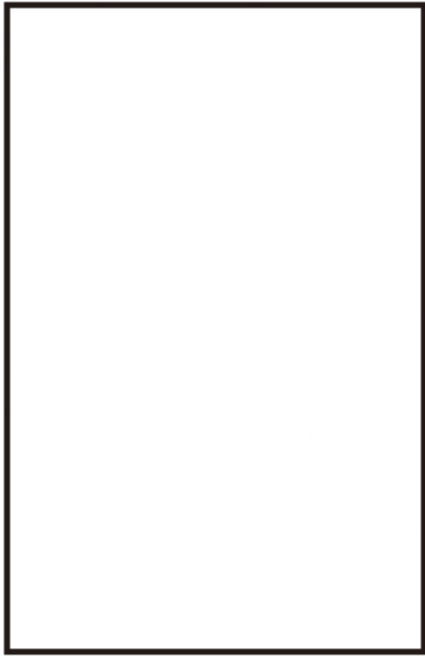

User Manual

Knowing The Product

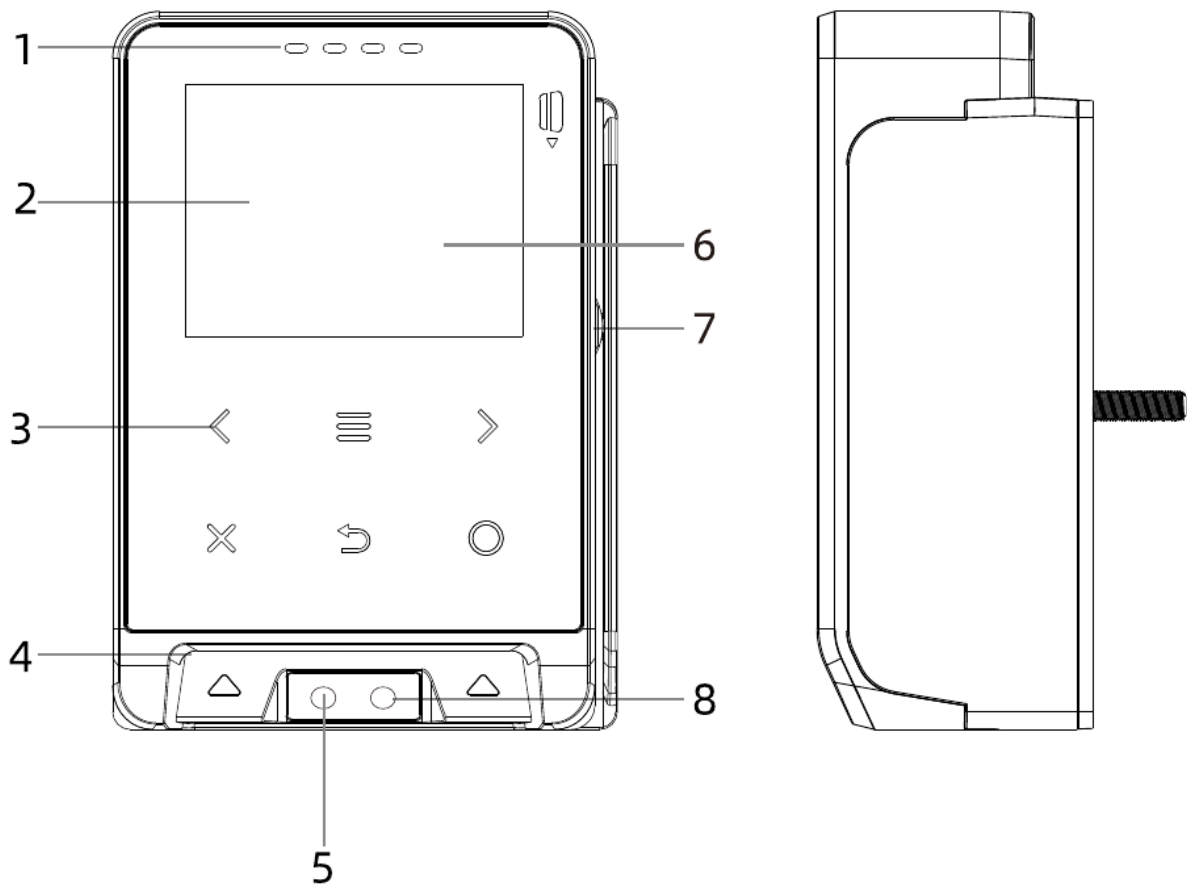

- 1. Status indicator
- 2. LCD touchscreen
- 3. Touch key
- 4. Smart card reader
- 5. Camera locator light
- 6. Contactless card interface
- 7. Magnetic strip card reader
- 8. Code scanning camera

8.Cancel key

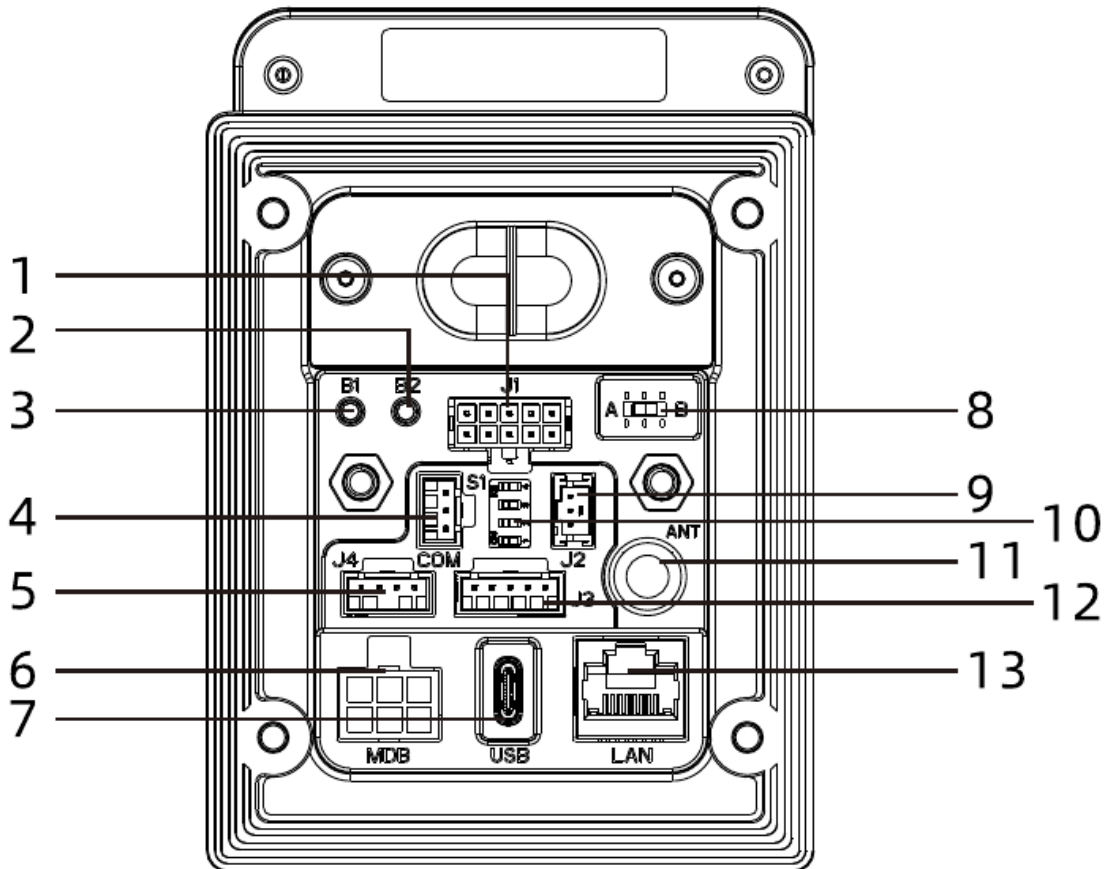

1. R\$232-A (host)
2. Key2
3. Key1
4. Com port
5. J4 port
6. MDB port
7. USB Type C port (OTG)
8. Slide switch
9. J2 port
10. Code switch
11. ANT
12. 3G/4G antenna (optional)
13. Ethernet port

SAM SIM and TF card Installation

- **Step 1:** please perform the following procedure after cutting off power .
- **Step 2:** place the terminal face down on a soft and clean surface to prevent scratch.
- **Step 3:** Unscrew 2 screws and open the SIM card cover(Fig.1).
- **Step 4:** insert SIM card that you need(Fig.2).
- **Step 5:** Install the cover and tighten the screws.

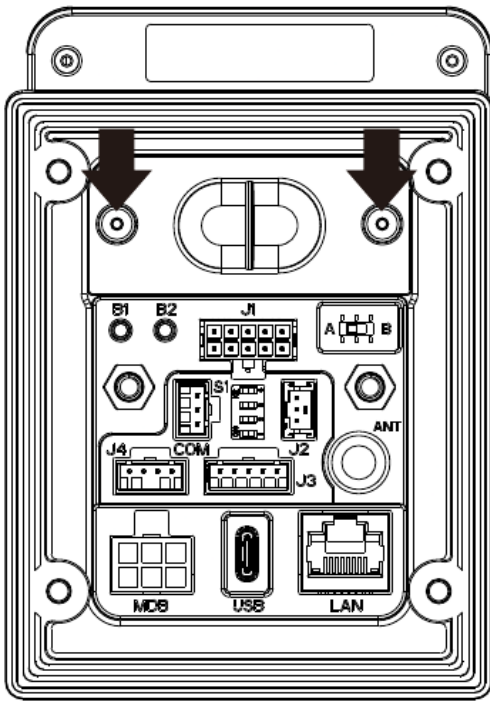

Fig.1

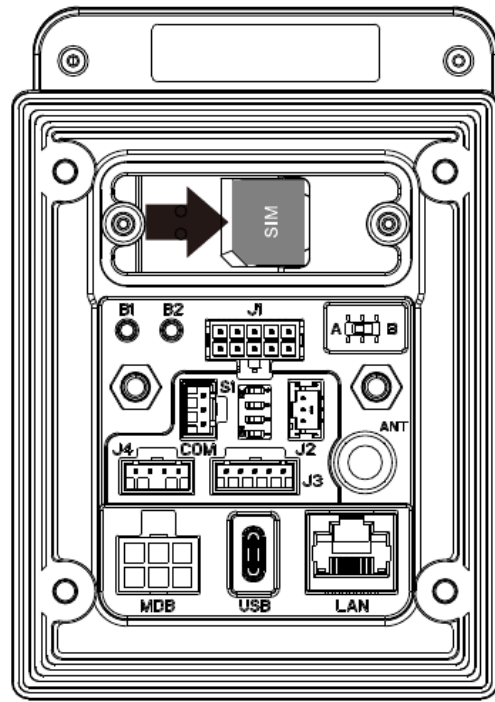

Fig.2

Caution:

Note that the orientation of cards should match with card slots. This device can be damaged by static charge, please operate following sensitive electronics device regulations.

Maintenance and Usage

Maintenance and Usage

- 1.If any cables become damaged, seek a replacement.
- 2.Do not insert unknown materials into any port on the Su3, this may cause serious damage to the device.
- 3.If repairs are required, please contact a professional technician instead of attempting them on your own.
- 4.The Su3 contains tamper-proofing features; these circuits will trigger if the device is disassembled, at which point it will have to be rearmed before the device is ready to resume operation.
- 5.The IM30 is designed for indoor use; however, during normal use its surface should still be kept clear of dirt and possible liquid contaminants. While the IM30 is designed to resist ingress of dust and liquids, it is not designed to resist pressurized liquids such as water hoses. Keep the back of the device away from dust and liquids as much as possible.
- 6.Make sure the various cables connect to provide the appropriate voltages at the proper pins.

Statement

- The company will not be responsible for the following action : Usage and / or damage under maintenance not following this user manual .

Copyright

- The author of this manual is Fujian Wazan Technology Co., Ltd.

According to Copyright Law of the People's Republic of China, the author benefits and reserves all the copyrights and other exclusive rights . Without the permission of the copyright owner, it is not allowed to copy, add or subtract, excerpt, reproduce or imitate partial or whole of this manual .

- The content of this manual is to instruct users to use the product correctly . Regarding on the content of this manual, Fujian Wazan Technology Co., Ltd disclaims any responsibility for any express or implied assurance .

Warning

- For any damage / issue caused by using unauthorized accessory or consumable (not provided or approved by Wazan), Wazan holds no responsibility . Without the permission of Wazan , it is not allowed to modify or change Wazan product .
- Any Changes or modifications not expressly approved by the party responsible for compliance could void the user's authority to operate the equipment.

This device complies with part 15 of the FCC Rules .

Operation is subject to the following two conditions :

1. This device may not cause harmful interference .
- 2.This device must accept any interference received , including interference that may cause undesired operation .

Note

- This equipment has been tested and found to comply with the limits for a Class B digital device , pursuant to part 15 of the FCC Rules . These limits are designed to provide reasonable protection against harmful interference in a residential installation . This equipment generates, uses and can radiate radio frequency energy and, if not installed and used in accordance with the instructions , may cause harmful interference to radio communications . However , there is no guarantee that interference will not occur in a particular installation . If this equipment does cause harmful interference to radio or television reception , which can be determined by turning the equipment off and on, the user is encouraged to try to correct the interference by one or more of the following measures :
 1. Reorient or relocate the receiving antenna .
 - 2.Increase the separation between the equipment and receiver .

- 3. Connect the equipment into an outlet on a circuit different from that to which the receiver is connected .
- 4. Consult the dealer or an experienced radio / TV technician for help .

Disclaimer

- In case of product update , the detail of the manual may mismatch with the product . The product shall prevail . We reserve the right to correct and / or update any content in this manual without notice .
- Manufacturer: Fujian Wazan Technology Co., Ltd.
- Address: 601,Building1, Huajian mansion, No.12 Science and Technology East Road, High-tech Zone, Fuzhou, Fujian, China
- Website: [Http://www.wazantech.com](http://www.wazantech.com)