

TRNDlabs FADER Hawk Drone User Manual

Manualsum, simplified manuals

Table of Contents

- [TRNDlabs FADER Hawk Drone User Manual](#)
 - [Parts Identification](#)
 - [Functions](#)
 - [Drone Functions](#)
 - [Controller Functions](#)
 - [Controller Battery Installation](#)
 - [Mobile Phone Holder Installation](#)
 - [Setup](#)
 - [Charging FADER Hawk](#)
 - [Pairing](#)
 - [Piloting](#)
 - [Take-Off & Land](#)
 - [Throttle Control](#)
 - [Flight Controls](#)
 - [Direction Control](#)
 - [Rotation Control](#)
 - [Setup App](#)
 - [App Installation](#)
 - [Connecting](#)
 - [App Functions](#)
 - [Back to Home](#)
 - [Show / Hide Buttons](#)
 - [Photo & Video](#)
 - [Taking a Photo](#)
 - [Recording a Video](#)
 - [Playing Back Videos / Viewing Photos](#)
 - [Saving & Deleting Photos / Videos](#)
 - [VR & Preview Mode](#)
 - [Switching VR Mode ON / OFF](#)
 - [1080p Preview Mode](#)
 - [Tips & Tricks](#)
 - [Speed Control](#)
 - [Controller Speed Control](#)
 - [Advanced Flight: Performing 360 Flips](#)
 - [Left Side 360° Flip](#)

- [Right Side 360° Flip](#)
- [Forward 360° Flip](#)
- [Backward 360° Flip](#)
- [Switching Modes](#)
- [Optical Flow Positioning](#)
- [Troubleshooting](#)
 - [Adjustable Camera](#)
 - [Light switch](#)
 - [Indoor Obstacle Avoidance](#)
 - [Gyroscope Correction](#)
 - [Trim](#)
 - [One Key Return](#)
 - [One Key Take Off / Landing Emergency Stop \(Press and Hold\)](#)
 - [Light Switch](#)
 - [Take Photo / Video Light](#)
 - [Replacing Rotor Blades](#)
- [FAQ](#)
- [Safety Precautions](#)
 - [Additional Safety Precautions](#)
 - [Battery Safety Instructions](#)
- [Warranty](#)
 - [Limited 1 - Year Warranty](#)
 - [Repair / Replace Product](#)
 - [Preparation For Shipping Your Product](#)

TRNDlabs FADER Hawk Drone User Manual

TRNDlabs FADER Hawk Drone User Manual

Hannuowei Toys Factory Remote control four axis User Manual

FCC id: [2AD4W-F1](#)

FADER Hawk



Parts Identification

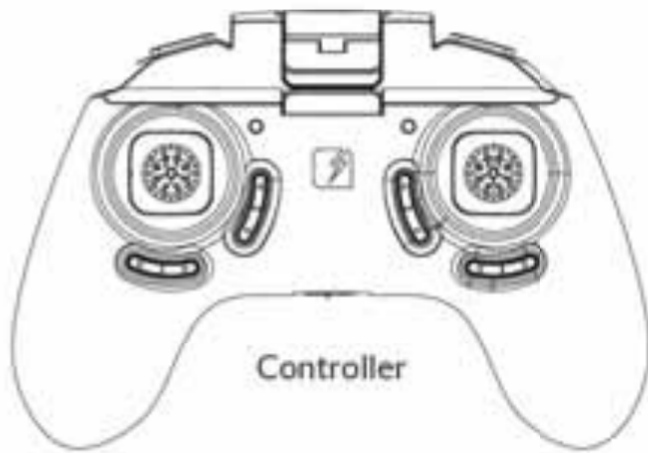

Charging Cable

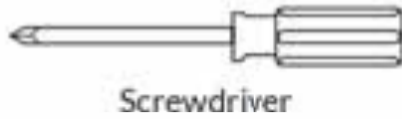

Screwdriver



4x Replacement Rotor Blades
Type A



FADER Hawk



4x Replacement Rotor Blades
Type B

Functions

Drone Functions

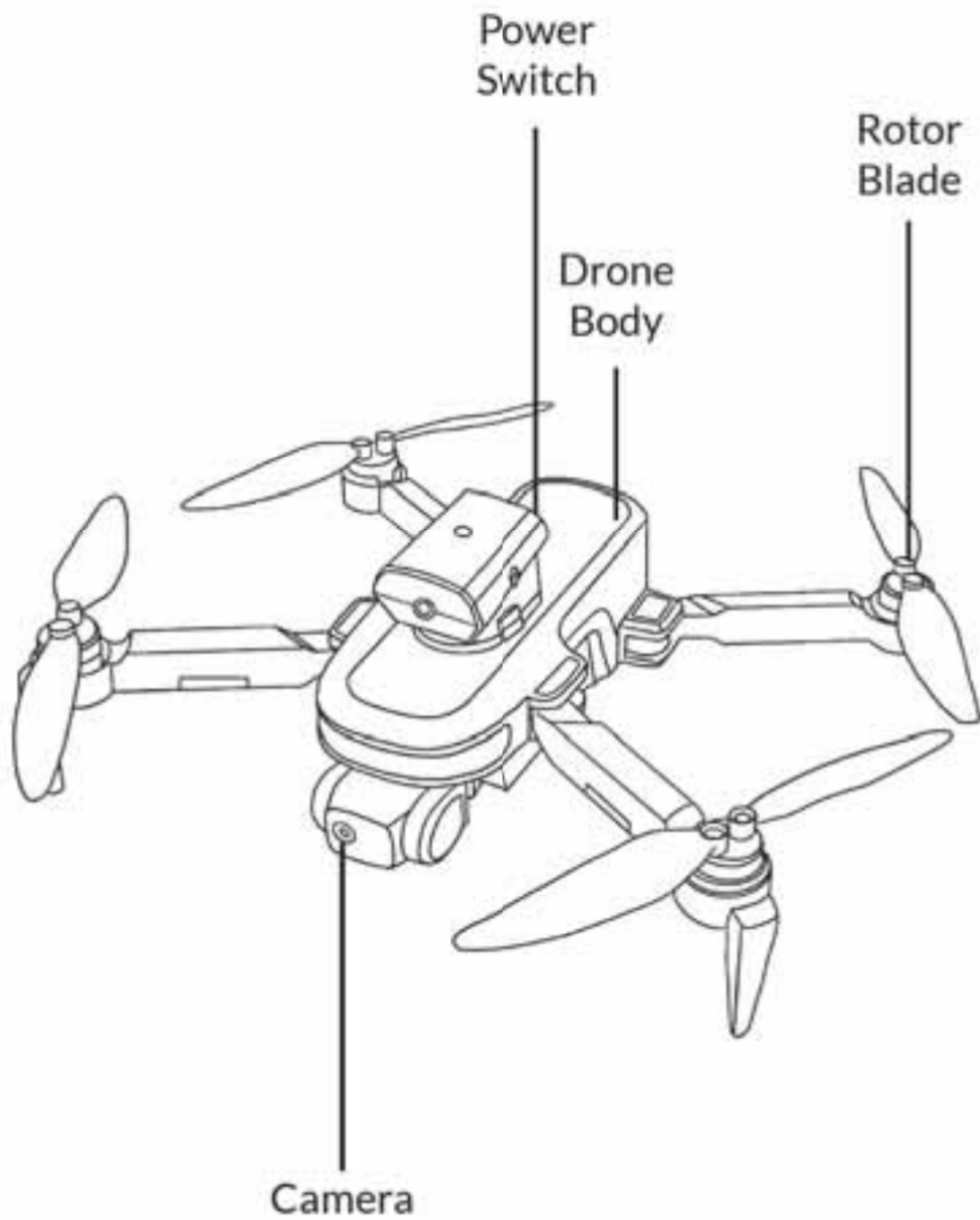

Controller Functions

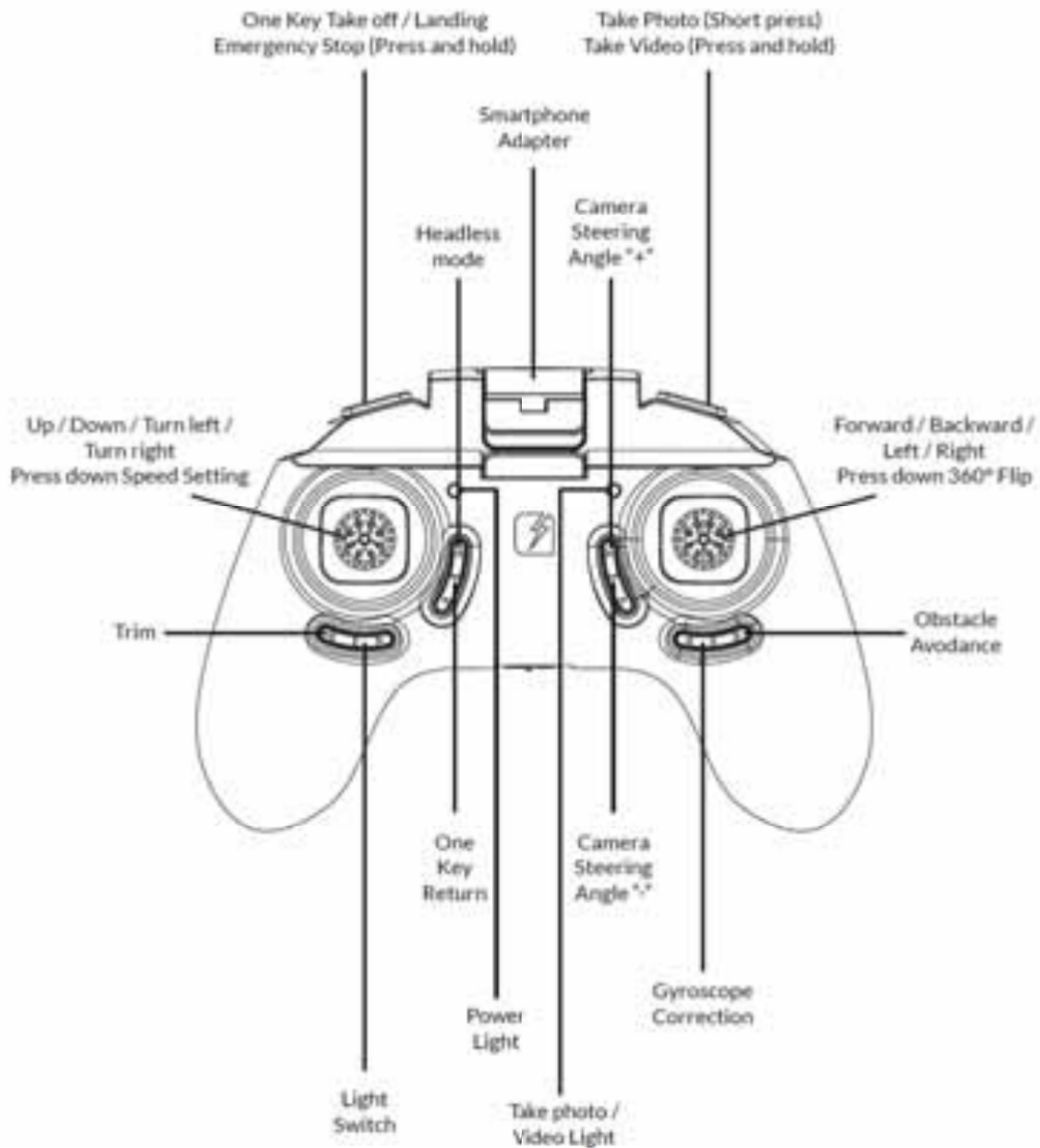

Controller Battery Installation

1. Open the Controller battery cover.
2. Install 4x AAA batteries.
3. Put the Controller battery cover back.

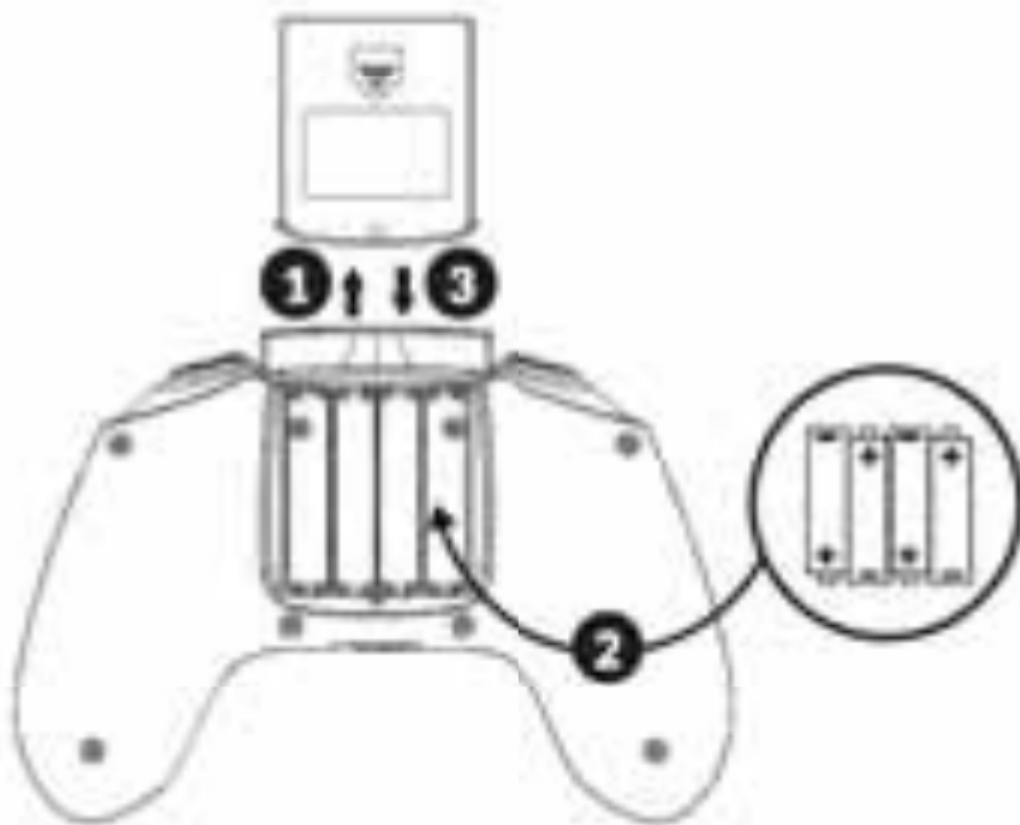

Mobile Phone Holder Installation

Slide the Mobile Phone Holder from closed position to open position. You can now place a mobile phone.



Setup

Charging FADER Hawk

1. Slide the battery out of the drone by pulling it gently.

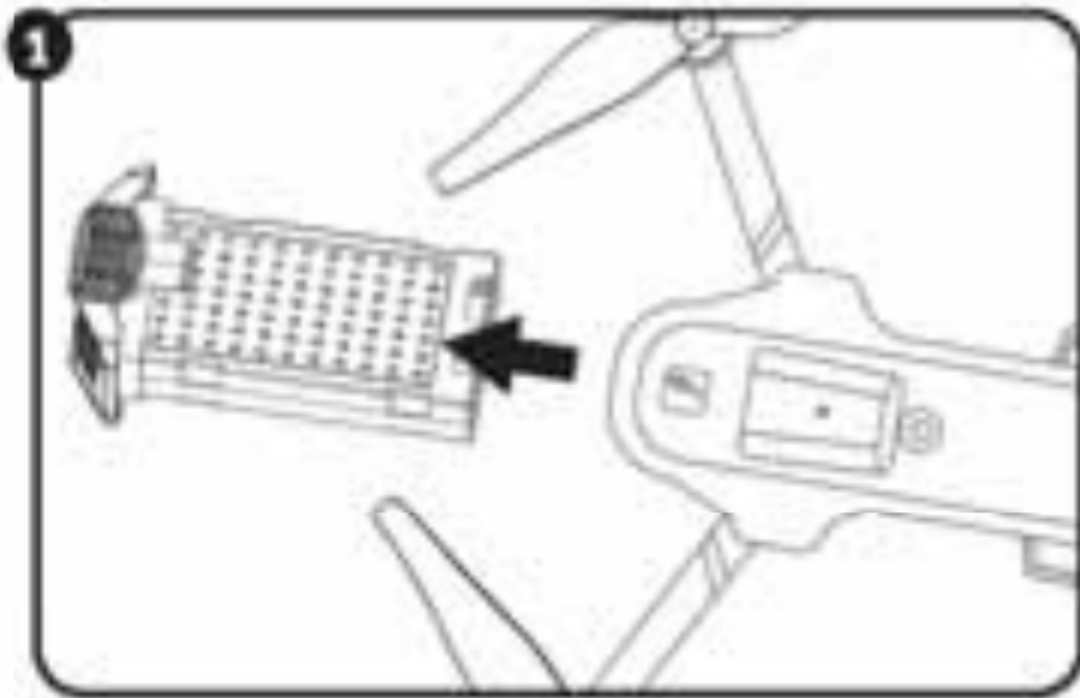

2. Connect the battery with the USB charging cable to a USB port or a USB wall adapter. A LED light on the battery will indicate that it is charging. When the battery is fully charged, the LED light on the battery turns off. It takes about 150 minutes to recharge a discharged battery.

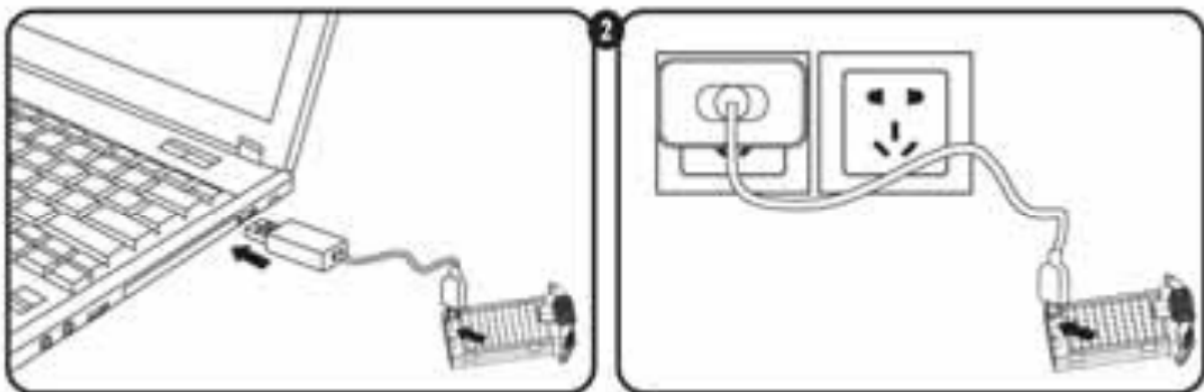

WARNING

Make sure you only charge the rechargeable battery with the supplied USB Charging Cable. If you try to charge the rechargeable battery with a different battery charger, this might cause serious damage,

Pairing

Gently unfold the arms of the drone and place the drone on a flat and level surface.

1. Press the Power Switch to turn on the Controller. The Blue Power Light starts flashing fast.
2. Press the Power Switch to switch the drone ON. The LED lights of the drone starts flashing fast.
3. Push the Throttle/Rotate stick to the full up position, then to the full down position. The Indicator Light on the controller and the LED lights on the drone turn solid.
4. The drone is ready to fly.



Piloting

Take-Off & Land

1. Pushing the Throttle/Rotate button upward will cause the rotors of the drone to spin without taking off. Pushing the same button downwards will cause the rotors of the drone to stop spinning.
2. To take off the drone press the One Key Take Off Button. The drone will hover at approximately 1.5 meters.
3. When flying, press the One Key Take Off Button again to land the drone.
4. In case of an emergency, press and hold the One Key Take Off Button for 3 seconds. This will stop the rotors and cause the drone to fall out of the sky.



Throttle Control

To fly higher, push the Throttle/Rotate stick cautiously forward.

To fly lower, push the Throttle/Rotate stick cautiously backward.



Flight Controls

Direction Control

To fly the drone forward or backward, push the Direction stick cautiously forward or backward.

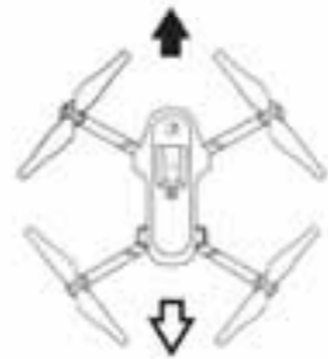
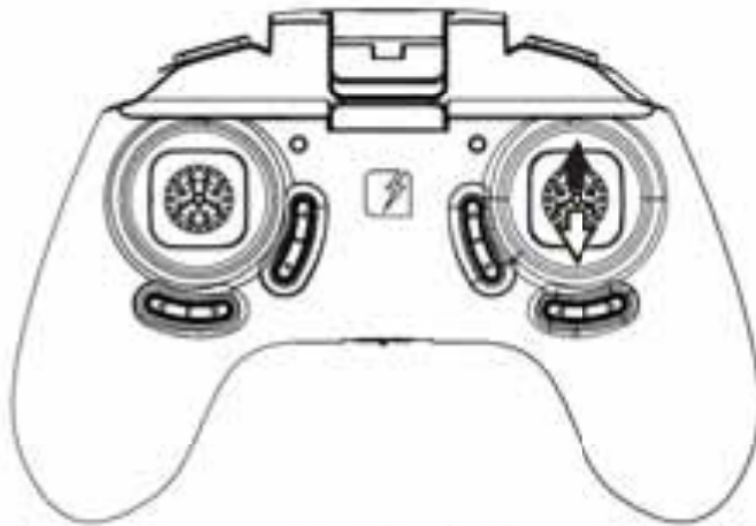

To fly the drone to the left or the right, push the Direction stick cautiously to the left or the right.

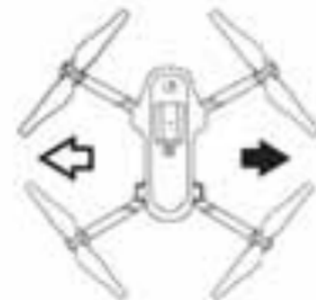

Rotation Control

To make the drone circle to the left or right, push the Throttle/Rotate stick cautiously to the left or right.

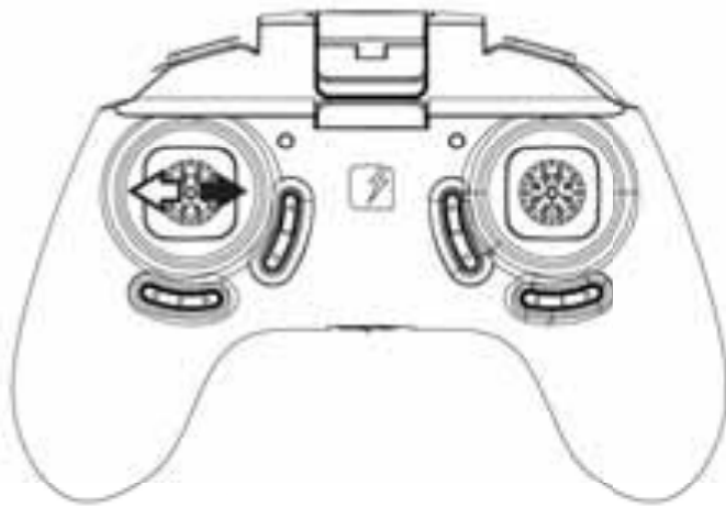

Setup App

App Installation

The App is suitable for mobile phones with iOS or Android. The App can be downloaded from the App Store or Google Play.

Scan the QR code to download the App: TRNDlabs FADER Hawk



For mobile phones with iOS, search TRNDlabs FADER Hawk in the App Store.

For mobile

TRNDlabs FADER Hawk Drone User Manual

Connecting

1. Pair the drone and controller, see chapter "Pairing".
2. Enter the setting of your mobile phone and turn on the WiFi.
3. Select "FADER Hawk" in the list of networks.
4. Go back and select the FADER App.
5. Tap on the icon to enter the Live Video interface.



5



App Functions



1. Back to Home.
2. Take a Photo.
3. Record a Video.
4. View Photos / Videos.
5. VR Mode.
6. 1080p preview.
7. Help.
8. Tap onscreen to hide - show buttons.

Back to Home

Tap the back icon to return to the home screen.



Show / Hide Buttons

Tap anywhere on the screen to hide the buttons. Tap again to bring up the buttons again.



Photo & Video

Taking a Photo

Tap the photo icon to take a photo. The icon will flash yellow momentarily, to notify a picture is taken. You can also take a picture with the Photo Button on the controller. Press the Photo Button once to take a photo.



Recording a Video

Tap the video icon to record a video. The icon will turn yellow when it's recording. Tap the icon again to stop recording, the icon will be black again. You can also record a video by pressing the Video Button on the controller for 3 seconds. Press the button again for 3 seconds to stop recording.



Playing Back Videos / Viewing Photos

Tap the gallery icon to view photo and video galleries.



Saving & Deleting Photos / Videos

In the photo or video gallery tap the selection icon (1) to enter selection mode.

Now select the file(s) you want to save to your phone's gallery (2) or delete entirely (3). Files that are saved show up in your phone's gallery on camera roll.



VR & Preview Mode

Switching VR Mode ON / OFF

Tap the VR Mode button to activate VR Mode. The button will turn yellow and the live feed from the drone will be visible as split screen. Press the button again to switch back to normal view.



1080p Preview Mode

Tap the 1080p Button to switch to 1080p preview mode.

The button turns yellow to indicate the Preview Mode is switched ON. Tap the button again to switch the 1080p Preview Mode OFF. The button will turn grey again to indicate the Preview Mode is turned OFF. By default the 1080p preview mode is ON.



Tips & Tricks

Speed Control

The drone has three speed settings: Low, Medium and High. A higher speed setting makes the drone faster.

Controller Speed Control

Press the Speed Control button on the top left of the controller to change the speed setting:

1. When the Controller emits 1 tone = Low speed mode
2. When the Controller emits 2 tones = Medium speed mode
3. When the Controller emits 3 tones = High speed mode

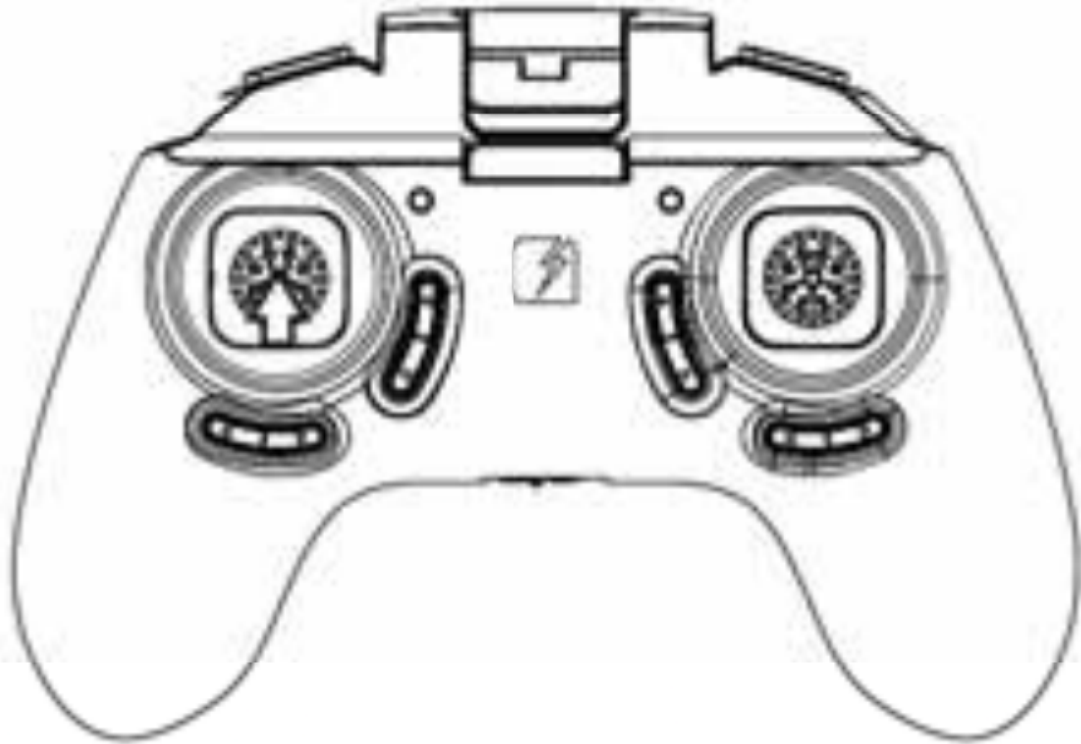

Advanced Flight: Performing 360 Flips

1. Press the Direction stick to enter flip mode. The Controller will start to beep.



2. Push the Direction stick forward, backward, right or left to perform flips. The drone carries out the flip in the respective direction.



WARNING

Do not attempt these stunts until you are able to fly confidently. Choose an area that will provide a soft landing (carpet or grass) and maintain an altitude of at least 10 feet/3 meter to allow room to recover control as you practice flipping the drone.

Left Side 360° Flip

Press the Direction stick and push it to the left.

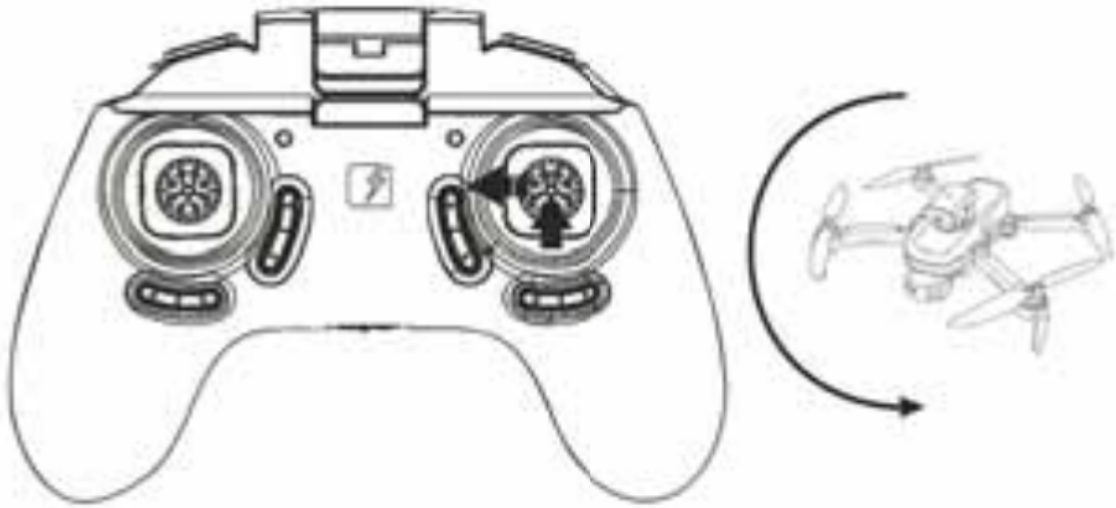

Right Side 360° Flip

Press the Direction stick and push it to the right.



Forward 360° Flip

Press the Direction stick and push it forward.



Backward 360° Flip

Press the Direction stick and push it backward.



Switching Modes

The drone can be switched from Normal Mode (A) to Headless Mode.(B) Headless Mode does not require the pilot to differentiate the front (head) position of the drone, but simply use the Direction Stick for the drone to respond correctly to the given input relative to the position of the controller.

To enter Headless Mode, press button (1). The controller will emit a beeping sound and the indicator light will flash to confirm the drone is now in headless mode. Press button (2) again to exit Headless Mode.

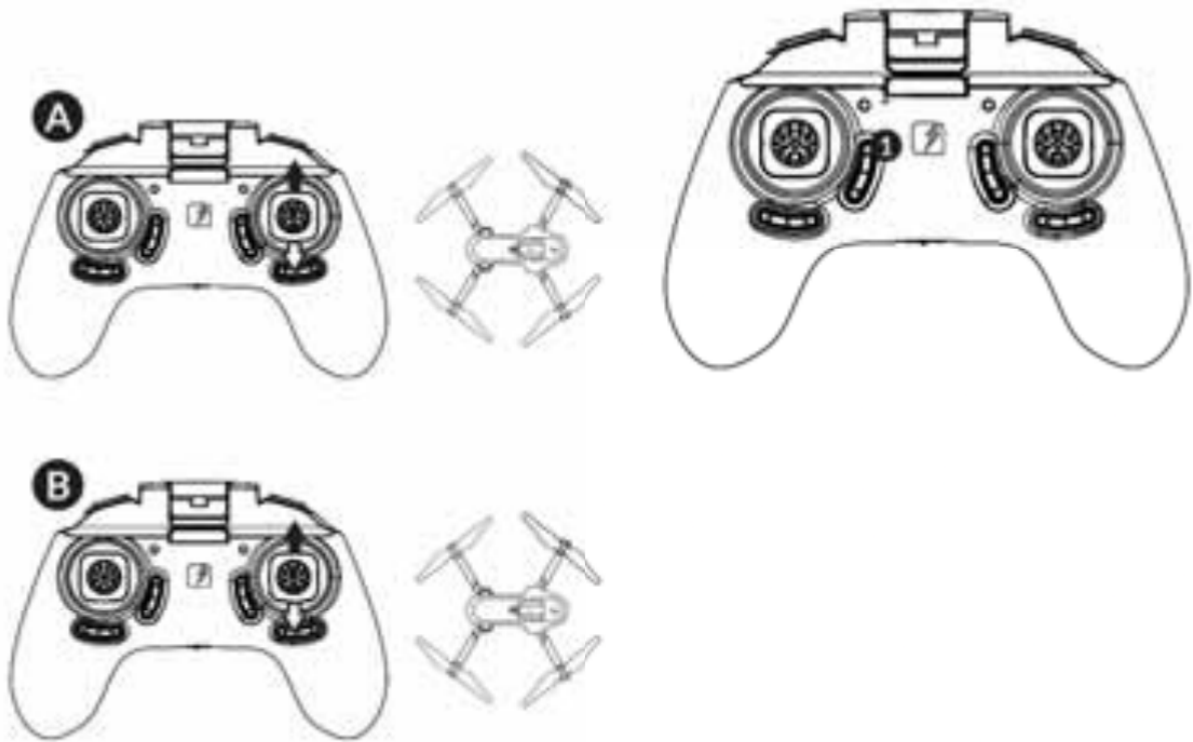

Optical Flow Positioning

The function of optical flow positioning helps the aircraft to:

1. Play a positioning role at a height of 5-6 metres.
2. Fix the aircraft in a place with a diameter of half a metre.



TRNDlabs FADER Hawk Drone User Manual

Troubleshooting

Adjustable Camera

When in the adjustable camera mode, the Angle of the remote control lens is about 80 degrees, and it can be adjusted about 80 degrees from the straight line down.

1. If you want to steer the camera 80 degrees upward, tap the Upward Camera Steering button in steps.
2. If you want to steer the camera 80 degrees downward, tap the Downward Camera Steering button in steps.

Light switch

3. If the light switch button is pressed, default light is activated.

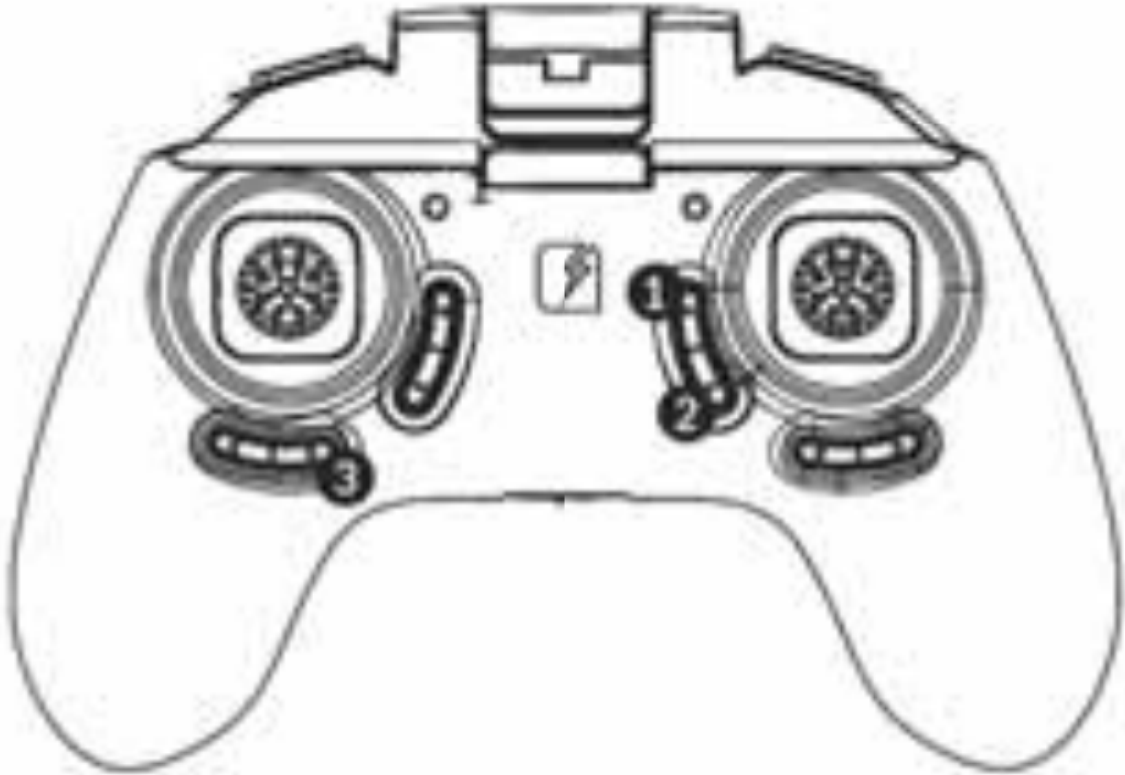

Indoor Obstacle Avoidance

When hovering in the air, proceed as follows:

4. If the indoor obstacle avoidance function button is pressed and the obstacle avoidance distance from the wall is 1.2 - 1.5 metres, the remote control will issue a drip alarm warning.

Gyroscope Correction

5. If the drone rotates to the left or right without moving the Throttle/Rotate stick, use the Gyroscope Correction button to establish balance and stability. This button is only used before takeoff and is not effective during flight. Press this button before takeoff and the drone's lights will blink for 2 seconds.

Trim

6. When hovering, if the drone drifts without you moving the Direction stick, press Trim button and use the joystick on the right to correct alignment.

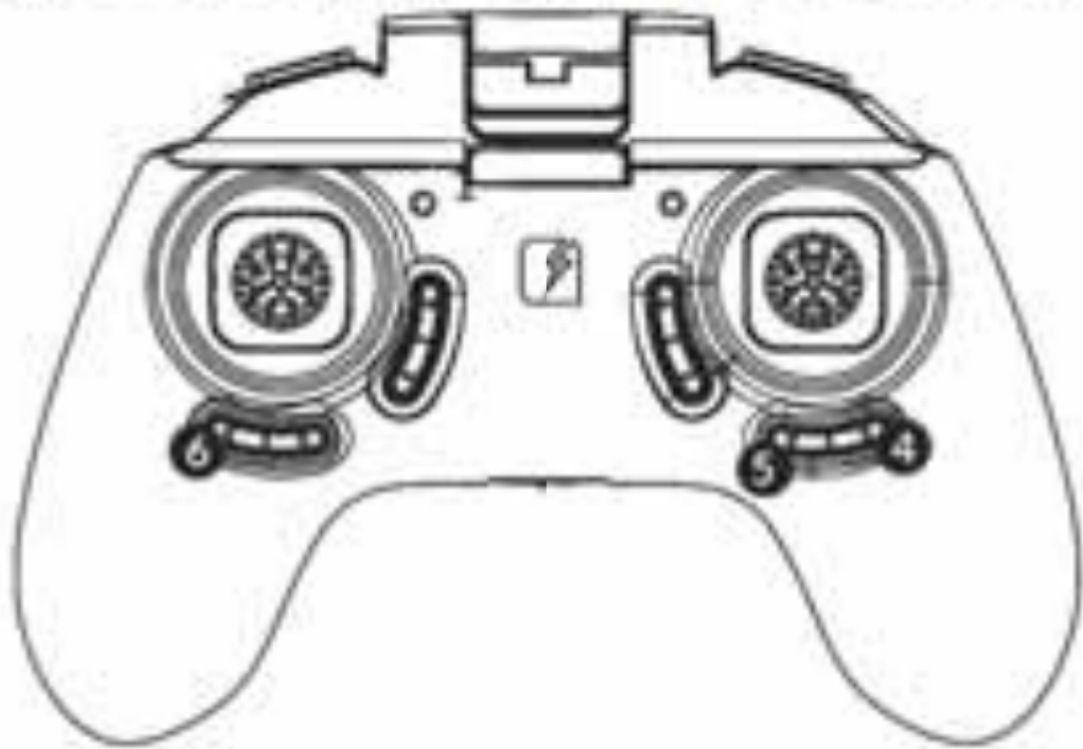

One Key Return

If this button is pressed, the drone will fly all the way back by default.

One Key Take Off / Landing Emergency Stop (Press and Hold)

Connect the drone and click to take off or land directly without pushing the joystick. Long-press this key to perform an emergency shutdown of the drone causing it to immediately fall to the ground.

Light Switch

When the drone is powered, this light will switch on.

Take Photo / Video Light

When the drone is taking a photo or a video, this light will turn on.

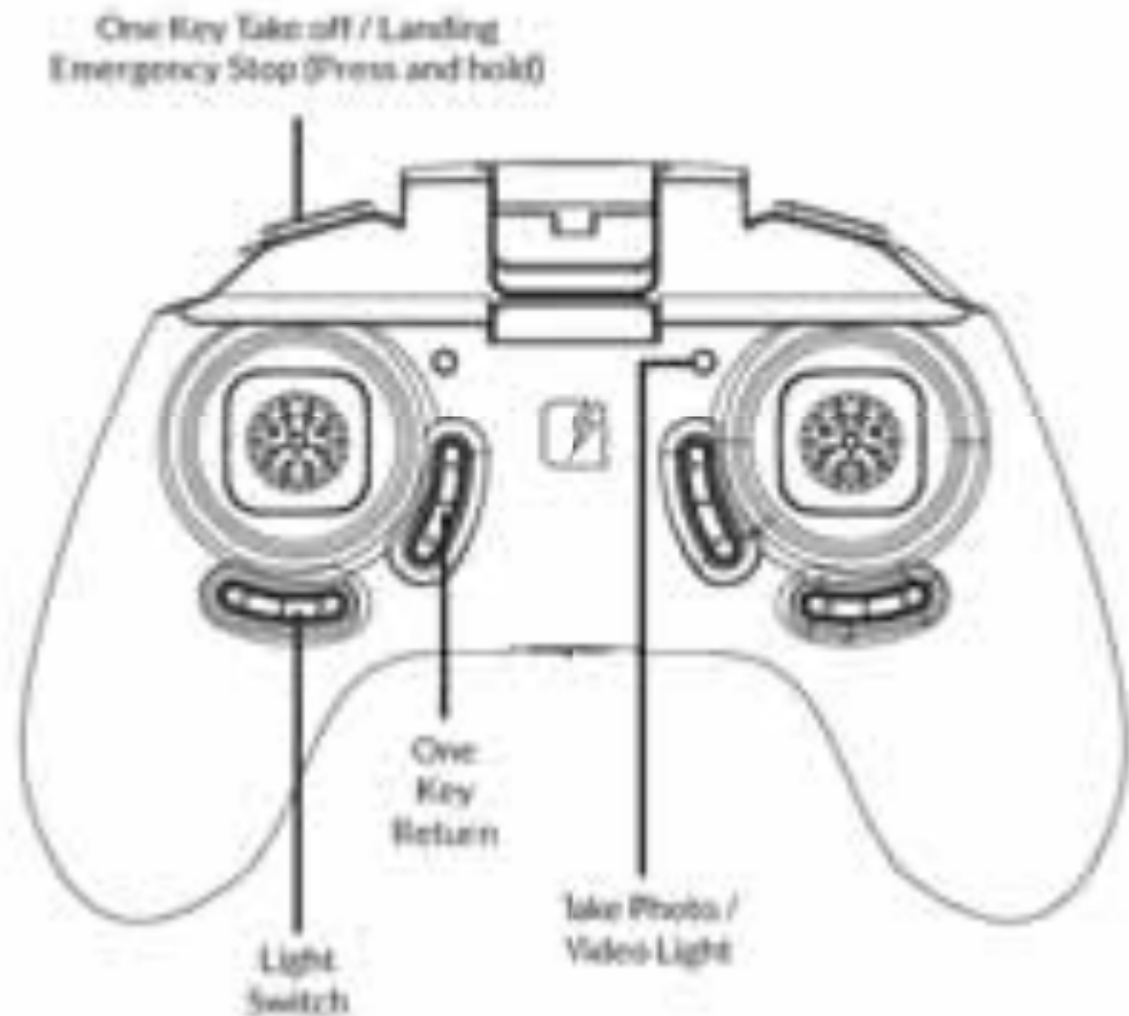

Replacing Rotor Blades

To replace a rotor blade, follow the steps below:

1. Put the Screwdriver in the screws marked A1, A2, B1 and B2.
2. Remove the screws and the Rotor Blades from the Drone.
3. Take the Rotor Blades marked A2 and put them on the Front Left: marking A1 and insert the screws using the Screwdriver to attach and tighten the Rotor Blades.
4. Take the Rotor Blades marked B2 and put them on the Front Right: marking B1 and insert the screws using the Screwdriver to attach and tighten the Rotor Blades.
5. Take the Rotor Blades marked A2 and put them on the Rear Right: Marking A2 and insert the screws using the Screwdriver to attach and tighten the Rotor Blades.
6. Take the Rotor Blades marked B2 and put them on the Rear Left: Marking B2 and insert the screws using the Screwdriver to attach and tighten the Rotor Blades.
7. Be sure to note the marking and the tilt angles of the Rotor Blades.

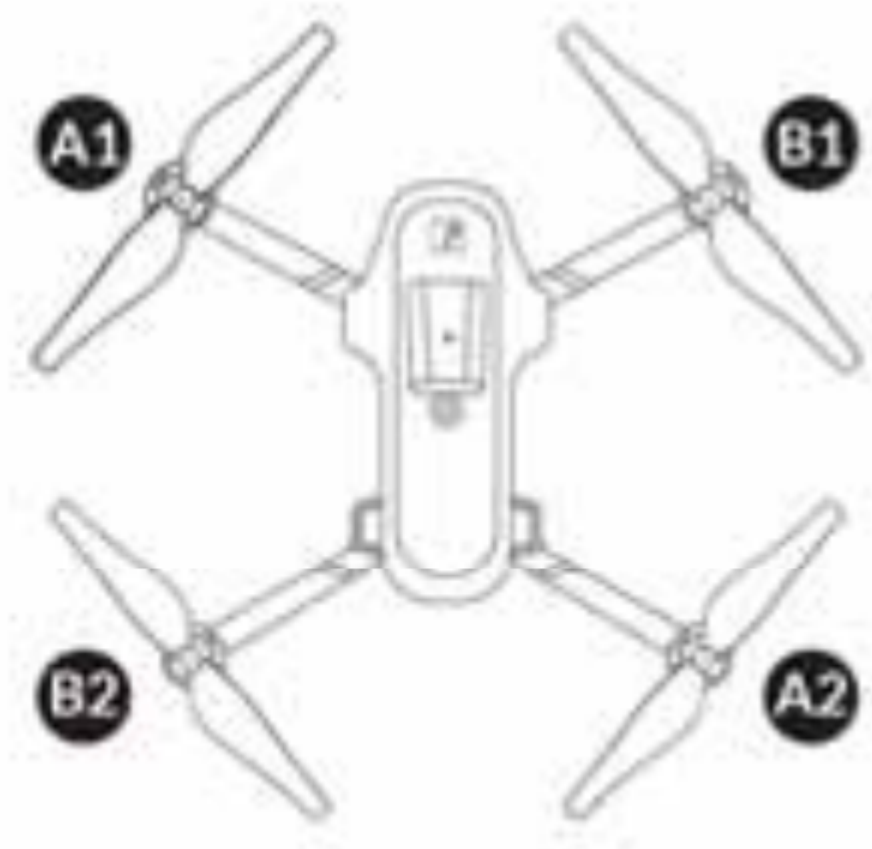

Front left: marking A1

Front right: marking B1

Rear left: marking B2

Rear right: marking A2

FAQ

•



Problem: Controller does not work.

- **Cause:** The batteries have been incorrectly inserted

•



inserted.

Solution: Check if the batteries have been correctly

[Manualsum](#)

- **Cause:** The batteries do not have enough power.
- **Solution:** Insert new batteries,

•



Problem: The drone cannot be controlled with the controller,

- **Cause:** The controller is possibly not correctly paired with the drone.

•



Solution: Carry out the pairing procedure as described in “Pairing”.

•



Problem: The Drone does not lift.

- **Cause:** the battery power is not sufficient.

•



Solution: Charge the battery as described in “Charging FADER Hawk”.

•



Problem: During flight, the Drone loses speed and height without any obvious reason.

- **Cause:** The battery is too weak.

•



Solution: Charge the battery as described in “Charging FADER Hawk”.

•



Problem: The drone only flies in a circle or flips over before taking off.

- **Cause:** Rotor blades incorrectly mounted or damaged.

•



Solution: Fit rotor blades / replace rotor blades as described in “Replacing Rotor Blades”.



Gallery.

Problem: Unable to find photos and videos in App



Solution: Photos and videos taken with the App are stored on the mobile device,

TRNDlabs FADER Hawk Drone User Manual

Safety Precautions

Carefully follow the instructions below. Make sure you fly the drone safely, and you mind the warnings. The drone is not intended for use by children under fourteen years old, unless directly supervised by a competent adult at all times.

Always ensure the safety of yourself, others and the drone. The drone has rotating blades that move at high speed and might cause damage or danger. Pilots are responsible for any actions that result in damage or injury due to improper operation of the drone.

Make sure you use the drone in a proper environment. Choose an adequate flying space without obstacles.

Keep your hands, face, hair or loose clothes away from the rotating blades. Hair getting into the rotor might cause serious damage of the drone.

Never lose sight of the drone. If the drone flies out of your field of view, immediately stop operating it.

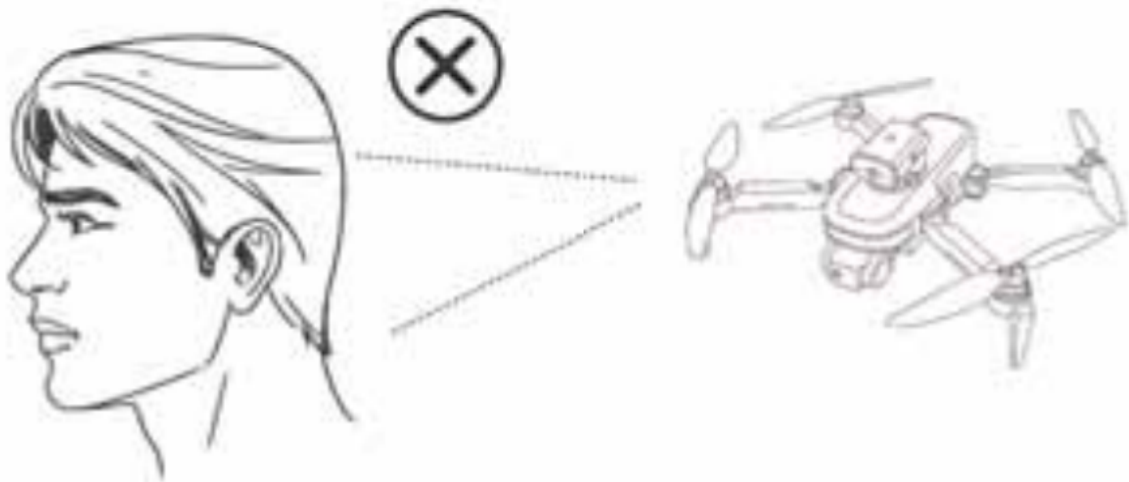
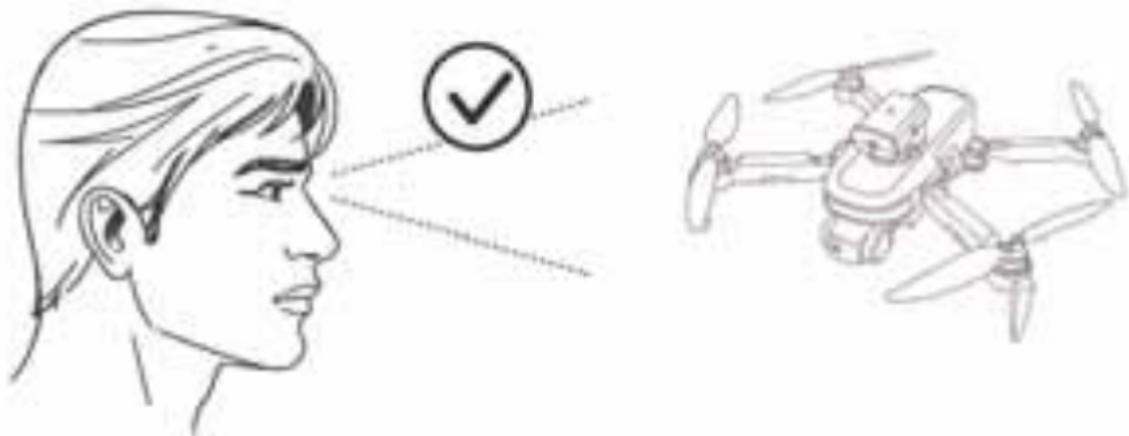

Do not fly near buildings. Do not fly over stations, railways or highways. Do not fly near trees, or crowds of people. Do not fly in rain, snow, fog, storm, wind or in unclear weather conditions at night.

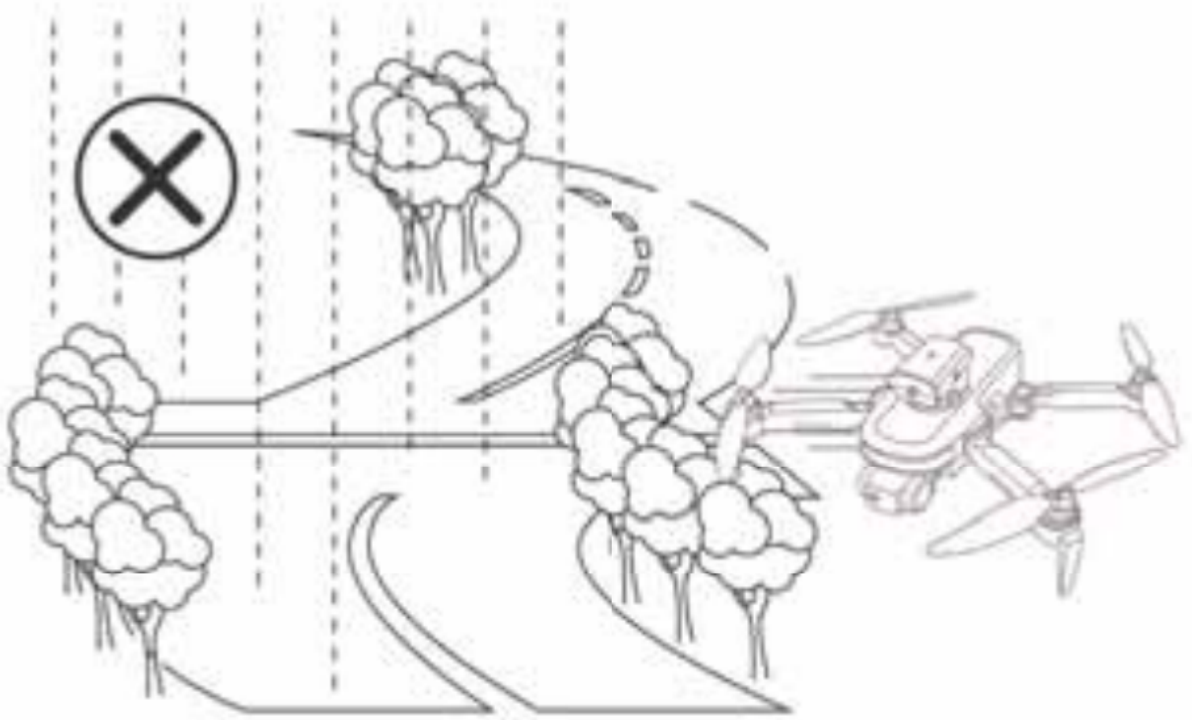

Do not approach or film people without their consent. Be mindful of privacy.

Avoid ceiling fans, hanging light fixtures, heating or air conditioning.

Additional Safety Precautions

- This drone has small parts that may pose a choking hazard. Keep all small parts and electrical devices out of the reach of children and animals. Pets can become excited by radio-controlled drones.
- The drone is controlled by radio, therefore it is subject to radio interference from many sources that are beyond your control. Radio interference can cause momentary loss of radio control. Always allow a safety margin in all directions around the drone in order to prevent collisions.
- The controller and the charger are specially designed to charge this model. Never use other charging equipments.
- Regularly examine the drone and controller for any damage to the plugs, enclosure, rotor blades, battery covers and other parts. In the event of any damage, neither the drone nor the controller should be used.
- When cleaning the drone or controller, use a damp cloth and wipe gently. Avoid using chemicals, it can damage the plastic components.

Battery Safety Instructions

- For the best performance, only use fresh 1, 5V Alkaline “AAA” batteries
In the controller,
- Never operate the drone with low controller batteries.
- The drone automatically switches off if the rotors are unable to rotate.
Switch the power 10 restart the drone.

[Manualsum](#)

- When not in use, store the drone in the original packaging with the batteries removed from the controller.
- Always recharge the battery after use In order to prevent it becomes deep discharged.
- Make sure to allow a pause of about 20 minutes between finishing the flight and recharging the battery.
- Even if the drone is not in regular use, recharge the battery occasionally, suggested at least once every 2-3 months,
- When transporting or temporarily storing the rechargeable battery, the temperature should be between 5-50 C. Do not store the battery or the drone in a car and do not expose it to direct sunlight. In case the battery is overheated it can be damaged or catch fire,
- Do not submerge the drone or the controller in water, This will damage the electronic components and could pose a severe risk to the built-in battery,

Warranty

Limited 1 - Year Warranty

TRNDlabs warrants to the original consumer that this product is free from any electrical or mechanical defects for a period of one year from the date of purchase. If any such defect is discovered within the warranty period, TRNDlabs will repair or replace the unit free of charge upon receipt of the unit, send it prepaid and insured to us. The warranty covers normal consumer use and does not cover damage that occurs in shipment or failure that results from alterations, accident, misuse, abuse, neglect, wear and tear, in adequate maintenance, commercial use or unreasonable use of the unit. Removal of any parts/components voids all warranties. This warranty does not cover the cost of repairs made or attempted outside by third-party Individuals or companies. Any applicable implied warranties, including warranties of merchantability and fitness, are hereby excluded. Some states do not allow limitations on the duration of implied warranties and do not allow exclusions of the incidental or consequential damages, so the above limitations and exclusions in these instances may not apply.

Repair / Replace Product

If your product begins to malfunction or stop working, Immediately email us at hello@trndiabs.com, If it is determined that a return is necessary, our warranty department will issue you an RMA number/form and the address to the nearest return center for shipping the product too. **IMPORTANT NOTICE:** We will reject all returns that are not accompanied by an issued RMA number, so make sure to contact us before attempting to return your product!

Preparation For Shipping Your Product

Please repack your product in a durable box, preferably in the original carton. Include the RMA form that was issued by us along with your daytime telephone number and email address inside the shipping carton. If you [Manualsum](#)

warranty has expired and you want an estimated fee for service, you may do so by simply emailing us and specifying the model and the problem.



WWW.TRNDLABS.COM

TRNDlabs FADER Hawk Drone User Manual