

# [AIFANNI Smart Toilet User Guide](#)

## [Manualsum](#), simplified manuals

### Table of Contents

- [AIFANNI Smart Toilet User Guide](#)
  - [Safety Instructions](#)
  - [Usage Method](#)
    - [Remote control instructions](#)
    - [Instructions for using keys on the main body side](#)
  - [Quick Start Installation And Comissioning](#)
    - [Other function description](#)
  - [Attachments](#)
  - [Installation Method](#)
    - [Installation procedure](#)
    - [Water pipe connection and installation](#)
  - [Trial Run](#)
  - [Other Functions & Daily Maintenance Methods](#)
    - [Body external cleaning](#)
    - [Nozzle cleaning method](#)
    - [Water filter cleaning method](#)
    - [How to pick up the cover plate](#)
  - [Technical Index](#)

## **AIFANNI Smart Toilet User Guide**

AIFANNI Smart Toilet User Guide

AIFANNI Intelligent Intergrated Toilet User Guide

Ningbo Huameiying Sanitary Ware Technology Smart Toilet User Manual

([2BB5D-51111](#))

## **Safety Instructions**

1. In order for you to use this product correctly, please read this manual carefully.

[Manualsum](#)

2. [f in doubt, please contact your local seller or agent. [The rated voltage of this product is 110V “120V~ 1000W power, please be sure to confirm before use.]
3. To improve performance, product specifications can be changed without prior notice. For the safety of yourself and others, to avoid unnecessary harm and loss, please strictly follow the following tips to use this product correctly

**Warning: Indicates a warning about how to avoid personal injury.**

**Note:** Indicates that some actions must be followed or avoided to prevent damage to equipment or other items, the content of the required signs are described as follows:

**Mark**

**Warn**



Do not disassemble, repair or transform the product by yourself, otherwise it may cause failure



Do not spray water or detergent on the product body or power plug, otherwise it may cause electric shock or failure



Do not unplug the power plug with wet hands, it may cause electric shock



Make sure the water source is clean and the water pressure meets the requirements



Must abide by

1. This product belongs to electrical products, do not place it in a place that is easy to be soaked for a long time
2. Please use sockets above 1000W
3. Make sure that the power socket of the product must be 110V~ 120V~, and the power socket of the 1000W product must be grounded.
4. The remote control battery uses 2 1.5V dry batteries, and the manual flushing battery uses 12V batteries.
5. If the power cord is damaged, it must be replaced with a special cord or special accessories purchased from its manufacturing organization or maintenance department.
6. Please use the accessories and connecting water pipes provided with this product.

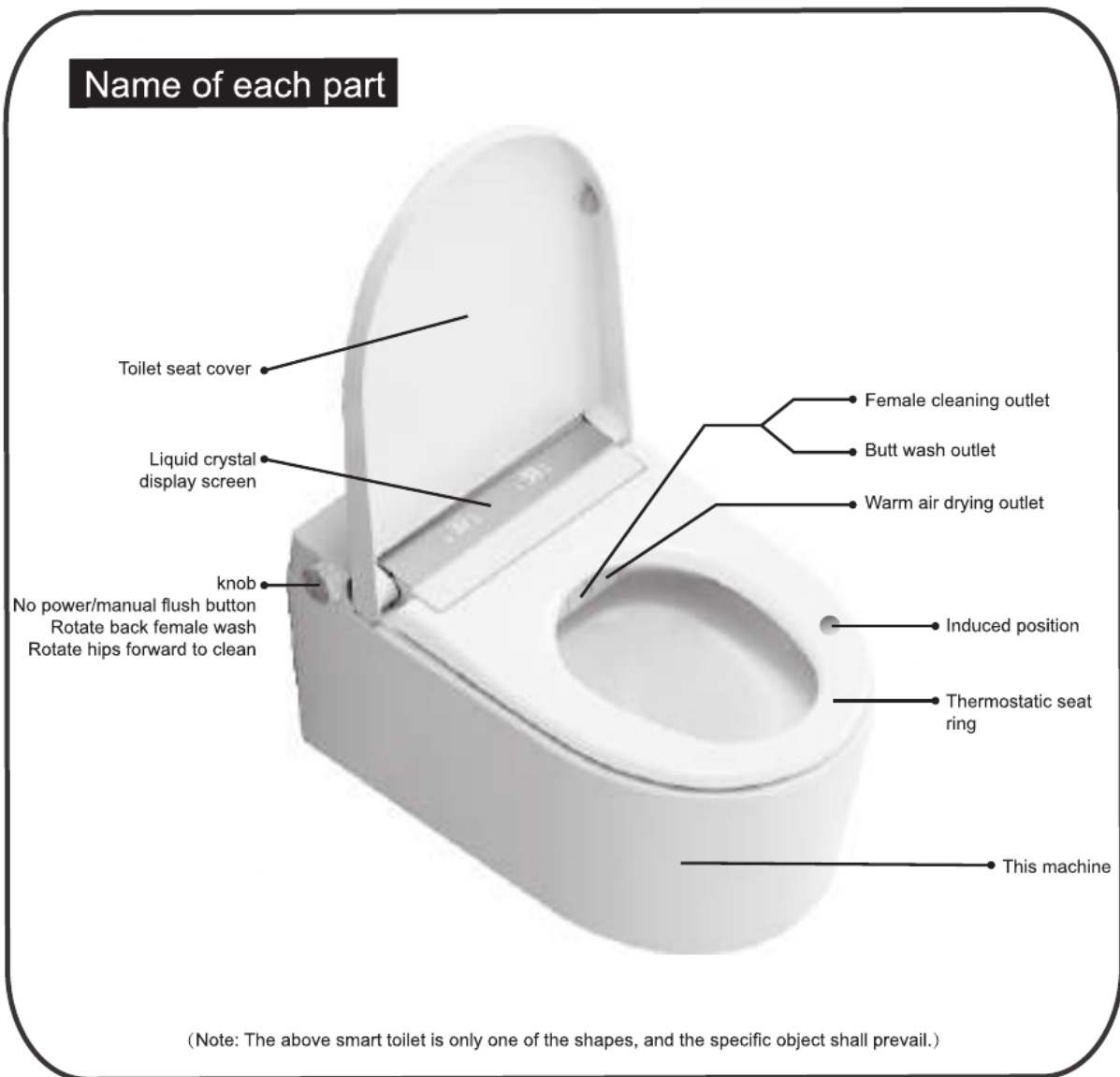

## Look Out

1. Do not step on the body and cover.
2. Do not use banana water, gasoline, medicine, cleaners or insecticide wipe this product
3. If you sit on the smart toilet for a long time, please set the seat temperature to low temperature to avoid burns. The following groups of people please pay attention to low temperature burns: young children, the elderly, patients, people who are unable to help themselves, and people who take drugs containing sleeping ingredients, drunk people, people who are too tired.

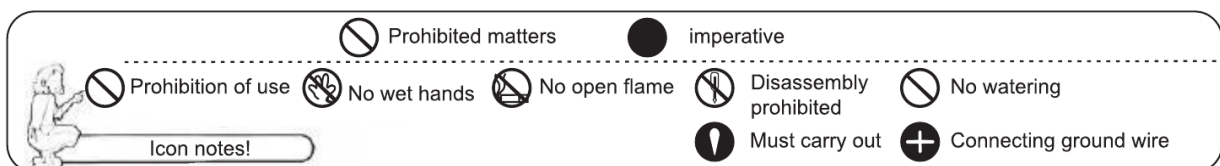



No wet hands

Do not touch electrical outlets and plugs with wet hands!

Touching with wet hands can cause electric shock!



Disassembly prohibited

Do not disassemble, repair or modify the fuselage without authorization!

Can cause fire or electric shock





Must carry out

When there is an odor or abnormal sound, unplug the power plug immediately!

- Unplug the power immediately!
- Please contact the customer service center in time!



Prohibit

Do not use damaged power outlets or power plugs. Contact customer service immediately in case of damaged parts.

- There is a risk of electric shock, short circuit, fire!





Prohibit

No open flame (cigarette butt, etc.)  
near the body cleaner!

---

- Easy to cause a fire!



Prohibit

Please be aware of cold burns.

---

- Even if the temperature is not high, but long-term contact with the same position on the seat, low temperature burns may occur.
  
- Please note the following groups.  
Young children, the elderly, the sick, the incapacitated, the drunk, the overtired
  
- ✘ In case of low temperature burns, please seek medical attention.



Prohibit

**Do not step on the toilet ring or place heavy objects!**

---

- The strong impact force will cause failure. Do not hold or step on the fuselage or control panel to avoid damage or personal injury.
- Children are not easy to play with.



No watering

**Do not allow the body cleaner to get wet or wet!**

---

- Can cause fire or electric shock!





Connecting  
ground wire

Use a socket with a ground terminal.  
It may cause malfunction or electric  
shock.

- For ungrounded sockets, be sure to entrust the designated electrical maintenance company to take grounding measures before use.
- When purchasing a separate socket, be sure to purchase a grounding socket.



Must carry out

Avoid contaminating the nozzle with  
excrement!

- Can be the cause of odors or failures.







In lightning weather, please unplug the power plug!

Must carry out



Do not lean on the cover and control panel!

Look out

■ Can be a cause of failure and breakage.





Prohibit

Do not plug more than one electronic product into the same socket!

---

- Avoid overheating of sockets and other phenomena.
- Avoid using unclean or damp electrical outlets.
- Make sure the power plug is in good contact with the socket.

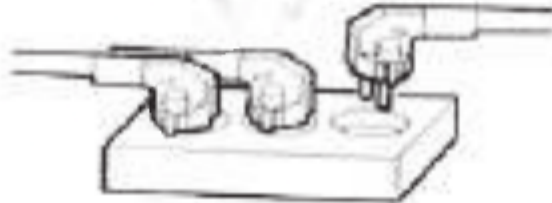

Prohibit

No use of industrial water or reclaimed water!

---

- To avoid skin damage!



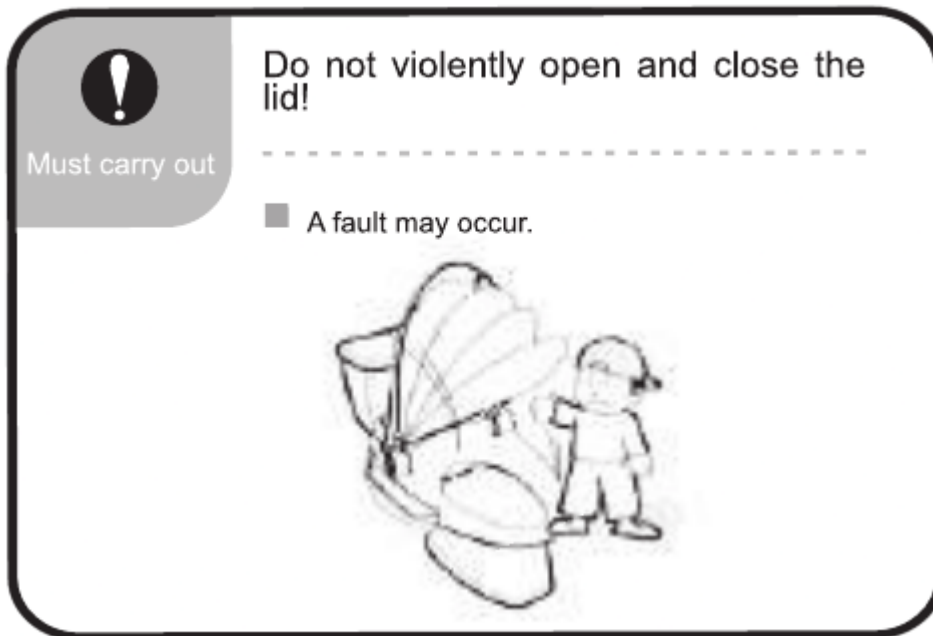

## Usage Method

### Remote control instructions



#### Stop key function

Pressing this button during use can immediately stop the current working state of the smart toilet

#### Flush key function

Press this button and the toilet will flush once

#### Warm air drying

After cleaning, press this function key to dry the buttocks with warm air; The toilet will flush automatically when dried by warm air

#### Water pressure regulating function

The need to adjust the amount of water in the cleaning process is divided into 3 levels

### **Spray rod adjustment function**

Refers to the need to adjust the cleaning position in the cleaning process, can be adjusted before and after the distance

### **Butt wash, female wash**

After the human body is seated, press this key, the nozzle will water to clean the buttocks, adjust the amount of water and the distance between the front and back according to your comfort, you can press the water pressure setting key to adjust.

Can also be switched to female cleaning, can also move forward and forward cleaning.

### **Seat temperature heating**

#### **seat temperature setting**

Heating according to seat temperature, seat temperature on, summer when not in use to turn off this function. According to the seat temperature setting, the seat temperature can be adjusted in 4 levels, the lowest temperature in 1 gear and the high temperature in 4 gear. After the human body is seated, it is no longer heated, because the human body already has a temperature, and the temperature is too high to bring discomfort.

### **Seat temperature, water temperature air temperature adjustment function**

Adjustment of seat ring temperature;

Cleaning water temperature adjustment;

Warm air drying temperature regulation;

### **Lighting function**

When the human body is not seated, press the night light key to turn on the luminous lighting function.

### **Code alignment process**

Power within 15 seconds, short press the remote control lighting key 3 times to code, hear a long sound on behalf of code success, code success can immediately operate the remote control

## **Instructions for using keys on the main body side**

### **Butt wash/mobile massage**

After the human body is seated, turn the knob back to the end and release, the spray rod will extend out and automatically clean, and then rotate again and release, and the spray rod will start to move back and forth for massage cleaning.

### **Stop key**

During operation, press the knob to stop all current operations.



### **Female cleansing/mobile massage**

After the human body is seated, rotate the knob forward to the end and release it, and the spray rod will extend out to clean automatically. Rotate once more, and the spray rod begins to move back and forth for massage cleaning.

### **Warm air drying**

After the body seat, the middle press is the warm air drying, and

## **Quick Start Installation And Comissioning**

### **Other function description**

#### **1. Enable the cleaning function**

The sensing position on the seat ring requires the human body to sit, or a wet cloth is placed on the sensor, and then the butt cleaning, female cleaning, and warm air drying can be enabled.



## **2. Damping buffer**

Smart toilet seat covers and seats come with damping buffers to prevent rapid toppling.



## **3. Self-cleaning sprinkler**

Sit on the smart toilet and press any cleaning key to self-clean the nozzle for 3 seconds to start the



# Attachments



Flange ring



Special hose



Inlet Angle valve



battery holder



Tank Angle valve



Functional remote control



Instruction manual

## Installation Method

### Warning

1. The smart toilet accessories have been debugged. it is strictly prohibited to disassemble and assemble without permission. Please use the parts and pipes provided by our company. Old parts and pipes cannot be reused. Please contact customer service if you have any questions.
2. All contents of this instruction manual are based on the latest situation of the product at the time of printing, and the company reserves the right to change without prior notice.

### Installation procedure

**Note:** Please try to keep the complete installation when installing

1. Use a triangle to draw a cross center line in the center of the blowdown pipe and extend it.



2. Place the toilet upside down on a soft mat, draw a cross center line in the center of the drain and extend to the four edges of the toilet.

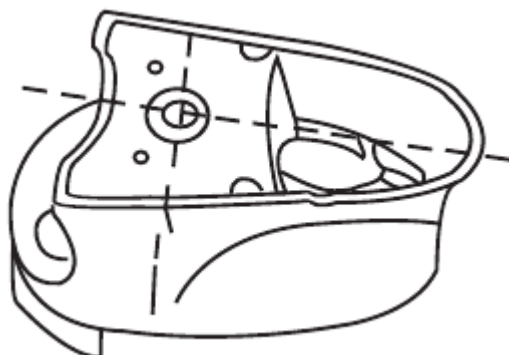

3. Align the toilet with the sewage pipe, and align the drawn cross line with the cross line of the sewage outlet.



4. Place the toilet upside down on a soft mat, evenly coat the inner ring of the sealing ring and the outer side of the toilet drain with glass glue, and firmly install the sealing flange ring on the bottom of the toilet drain.

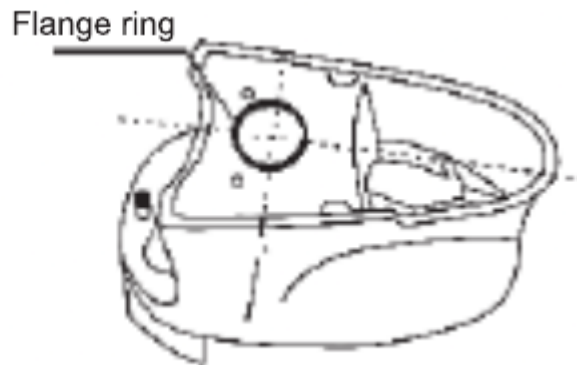

(Be careful to remove the plastic film from the packing ring.)

5. Align the toilet equipped with the sealing flange with the drain pipe port (make the center line coincide), and slowly press the toilet down until it is level.



6. Install the inlet Angle valve and connect the braided hose (before connecting the braided hose, please release the water in the pipe for 3-51 minutes to ensure that the pipe is clean and the inlet valve is not blocked).



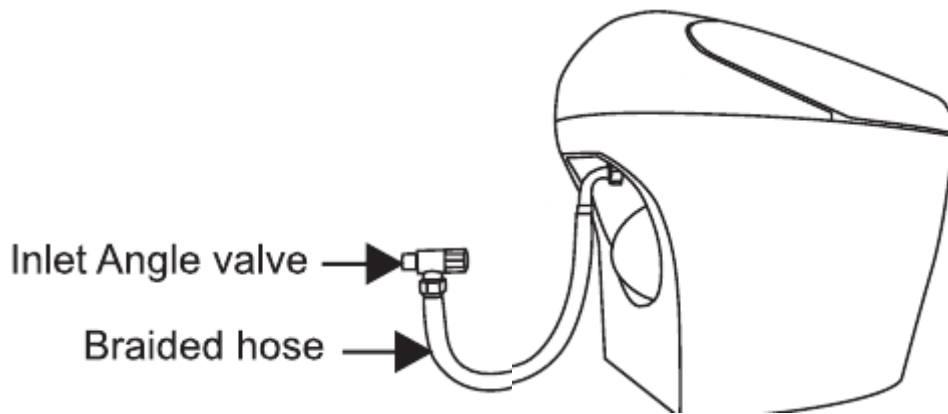

8. After the sealant solidifies, plug in the power and slowly open the Angle valve, adjust the water pressure within 7.5KG, and check the tightness of each connection point.

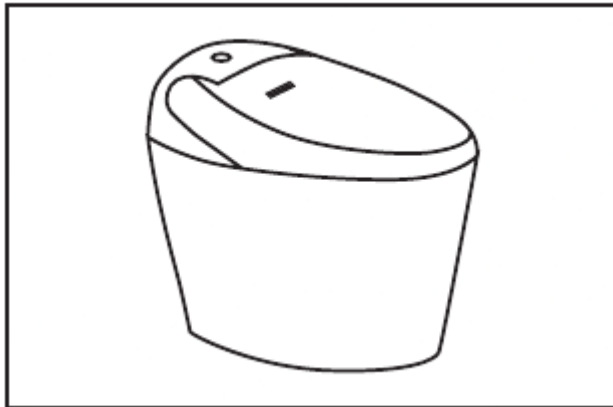

## Water pipe connection and installation

1. Connect one end of the braided hose to the wall corner valve, and connect the two outer ends to the three-way filter shell.
2. After plugging in the power supply, adjust the Angle valve to control the water pressure within <math>< 7.5\text{kg}</math>.

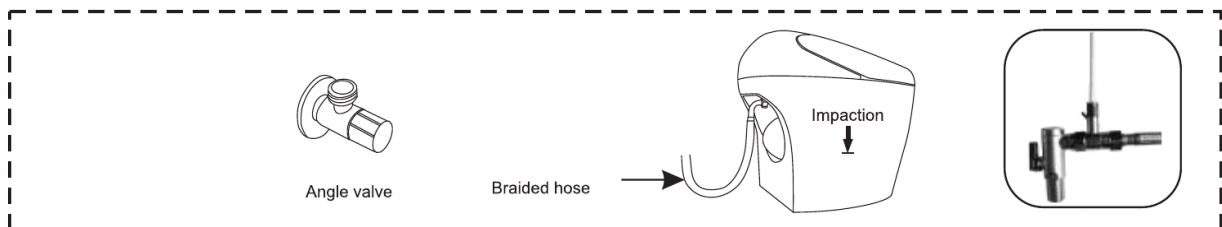

**Note:** This product uses super whirlpool siphon jet flushing technology, such as high water pressure area (more than 3 kg water pressure) ceramic inner wall super whirlpool flushing will appear a little splash and spray noise is too large, you can slowly adjust the Angle valve to the right, reduce the water pressure so that the flushing can work normally.

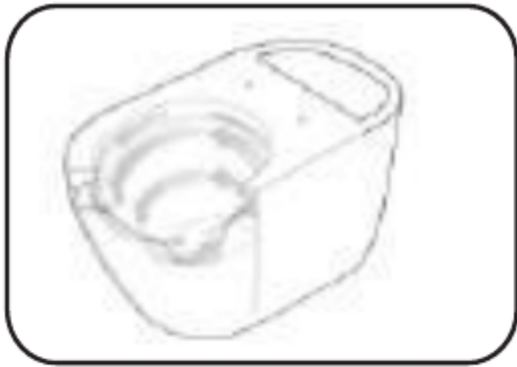

Superwhirlpool siphon  
jet flushing technology

**WARM REMINDER:**

After connecting the water pipe and opening the Angle valve, if the nozzle water appears in the new product, please plug in the power supply and it will automatically reset the nozzle and stop the water. Turn off the power and water supply before disassembly.

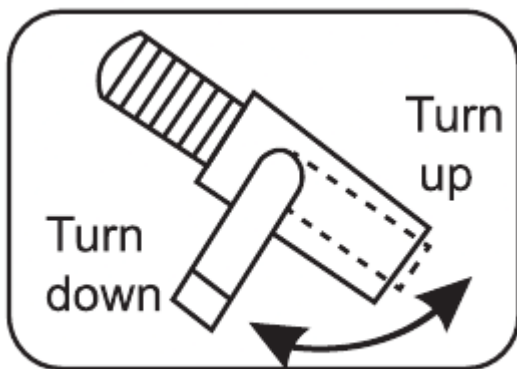

Regulating Angle valve

• **LOOK OUT**

1. In case of power failure during the cleaning process, please close the Angle valve and stop the water supply. The function recovers after a self-check.
2. Please be sure to use the tees and other accessories provided by our company.

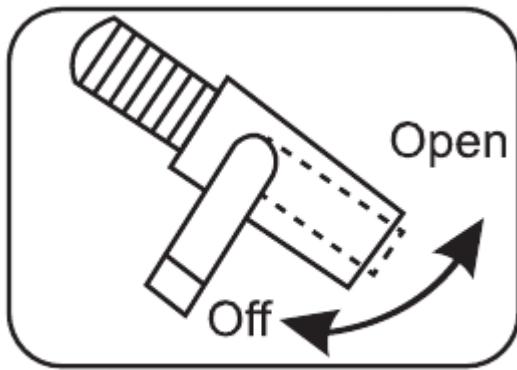

Closing Angle valve

## Trial Run

**Note:** For the first time, if the nozzle appears water after opening the Angle valve, it is a normal phenomenon, not a fault. After plugging in the power supply, the nozzle will stop running water after the product self-test function ends.

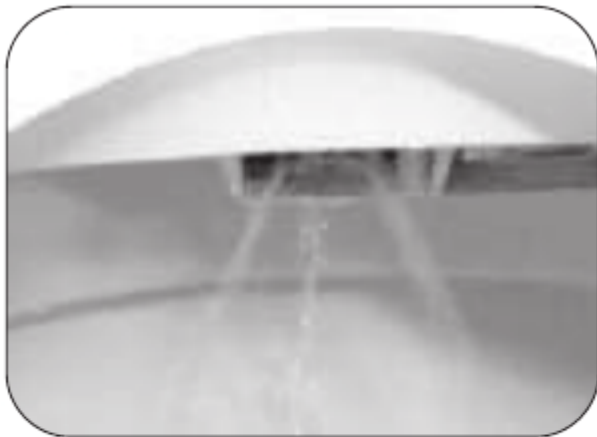

Nozzle mouth water is a normal phenomenon  
(For the first time)



Wet towel in inductive position  
(Confirm the induction light)



Power off flush button

### **FUNCTION VALIDATION**

1. Please confirm each function according to the instructions.
2. After plugging in the power supply, put a small wet cloth in the induction position of the seat circle (representing someone sitting) and the water temperature will be heated to the set temperature. Pressing the warm air drying button will start the warm air drying function (the warm air drying will not start when the person is not sitting). Please refer to the previous page to test the functions.
3. In the case of unplugged power and power failure, no function can be used. (Only no electric flushing function can be used, unless the water is cut off)
4. There are three ways to flush the toilet: automatic flush after use. When the person is not seated, press the remote control stop button to flush automatically. When no one is seated, press the side manual flush button to flush automatically. Press this button to flush automatically when there is no power.

# Other Functions & Daily Maintenance Methods

## Body external cleaning

1. The surface of the body should be wiped with a sponge or a soft dry rag or a rag with a viscous detergent.
2. Note: Do not use diluents, light gasoline, detergents, chemicals, etc., and do not spray insecticides, fragrances, deodorants, etc.

## Nozzle cleaning method

1. Please clean the nozzle regularly: first prepare the toothbrush and soft cloth. When no one is sitting, press the hip key or the female cleaning key, and the spray rod is extended to clean the nozzle and the nozzle.
2. Do not forcibly remove the nozzle, clean it with a toothbrush and a soft cloth, press the stop button after cleaning, the spray rod will automatically return.
3. **Note:** Do not reset the nozzle when it is pulled out, as this will cause faults.



## Water filter cleaning method

1. Close the corner valve to turn off the water source.
2. Loosen the cover of the three-way water inlet valve.
3. Remove the filter and clean it with a toothbrush before putting it into the tee.
4. Tighten the cover of the three-way water inlet valve.
5. Open the corner valve to supply water.



Rinse filter dirt with water

### **How to pick up the cover plate**

1. Remove the power plug.
2. Turn off the water supply valve.
3. Lift the body in the direction of the arrow.



Lift gently

**Do not open the top cover unless necessary**

**Note:** Please refer to the trial operation method when using again.

# Technical Index

Specification		110V-120V ~ 50Hz/60Hz 1000W	Seat ring heating device	Temperature regulation	Room temperature sensor 33 °C / Medium temperature about 36 °C / High temperature about 40 °C
Water supply	Way	Directly connected to water mains	Seat ring heating device	Heating power	45W
	Service pressure	0.15MPa-0.75MPa (1.5kgf/cm <sup>2</sup> -7.5kgf/cm <sup>2</sup> )		Safety device	Temperature fuse
Cleaning device	Required tap water flow	0.5L/min -0.9L/min	Warm air drying heating device	Temperature regulation	Room temperature sensor 45 °C / Medium temperature about 50 °C / High temperature about 55 °C
	Women's cleaning water	0.5L/min -0.9L/min		Heating power	250W
	Heating mode	Instant type		Safety device	Temperature fuse
	Tempera- ture regulation	Room temperature sensor 33 °C / Medium temperature about 36 °C / High temperature about 40 °C	Other safety devices		Leakage protector
	Heating power	1000W			1.5m
	Safety device	Temperature switch/Temperature fuse/Water level sensor	Net product weight		39Kg

- Confirm items before requesting maintenance

Symptom	Inspection method	Counterplan
No start at all	The power is off or the power socket is not connected	Make sure the power plug is plugged in
		Remove the power plug and reinsert it
The water is not flushed or the water is not smooth	Whether the water supply is off or the water supply valve is closed	Check the water source and open the water supply valve
	Whether the water filter is blocked	Please clean the filter
	Whether the nozzle is blocked by scale	Please clean the nozzle with a toothbrush
Leak	The connection of the water supply pipe is tight	Please tighten the connection of the water supply pipe
Water temperature, seat ring cool	Whether the water temperature and seat ring temperature are adjusted to normal temperature	Please readjust the temperature

**Note:** The rated power of the product is the ambient temperature of 23°C, the water pressure of 0.2MPa, and the water inlet temperature of 15°C. When the power starts, set the seat temperature, the water temperature of the post-washing, and the net flow rate of the post-washing to the highest gear (turn off the pulse and swing), immediately start the post-washing and continue to work steadily for the average power measured in a cleaning cycle. When the inlet water temperature exceeds the above range, the outlet water temperature of the nozzle may be unstable.

### AIFANNI Smart Toilet User Guide