



# Power Magic Ultra Battery B-130X

## User Manual



ENGLISH / 한국어 / 中文 /  
ESPAÑOL / 日本語 / FRANÇAIS

[www.blackvue.com](http://www.blackvue.com)

# BLACKVUE

---

## POWER MAGIC ULTRA BATTERY B-130X

For the latest version of the manual and customer support go to [www.blackvue.com](http://www.blackvue.com)

최신 사용자 설명서나 문의 사항은 BLACKVUE 홈페이지에서 확인하실 수 있습니다. [www.blackvue.co.kr](http://www.blackvue.co.kr)

如需最新版本的用戶手冊和客戶支持，請訪問網址 [www.blackvue.com/cn](http://www.blackvue.com/cn)

Para consultar la última versión del manual y obtener soporte al cliente, vaya a [www.blackvue.com](http://www.blackvue.com)

取扱説明書の最新版やカスタマーサポートについては[www.blackvue.com](http://www.blackvue.com)をご覧ください。

Pour obtenir la dernière version du manuel et contacter le service client, rendez-vous sur [www.blackvue.com](http://www.blackvue.com)

## FCC Compliance Information

### FCC Part 15.19 Statements

This device complies with Part 15 of the FCC Rules. Operation is subject to the following two conditions:

- (1) This device may not cause harmful interference, and
- (2) this device must accept any interference received, including interference that may cause undesired operation.

### FCC Part 15.105 Statement (Class B)

This equipment has been tested and found to comply with the limits for a Class B digital device, pursuant to part 15 of the FCC Rules.

These limits are designed to provide reasonable protection against harmful interference in a residential installation. This equipment generates, uses and can radiate radio frequency energy and, if not installed and used in accordance with the instructions, may cause harmful interference to radio communications. However, there is no guarantee that interference will not occur in a particular installation. If this equipment does cause harmful interference to radio or television reception, which can be determined by turning the equipment off and on, the user is encouraged to try to correct the interference by one or more of the following measures:

- Increase the separation between the equipment and receiver.
- Connect the equipment into an outlet on a circuit different from that to which the receiver is connected.
- Consult the dealer or an experienced radio/TV technician for help.

### FCC Part 15.21 Statement

Any changes or modifications not expressly approved by the party responsible for compliance could void the user's authority to operate this equipment.

### MPE

The antenna(s) must be installed such that a minimum separation distance of at least 20 cm is maintained between the radiator (antenna) and all persons at all times. This device must not be co-located or operating in conjunction with any other antenna or transmitter.

## ▶ BlackVue Power Magic Ultra Battery B-130X

The Power Magic Ultra Battery is designed to power your BlackVue dashcam in Parking Mode for extended periods of time without using your vehicle's battery.

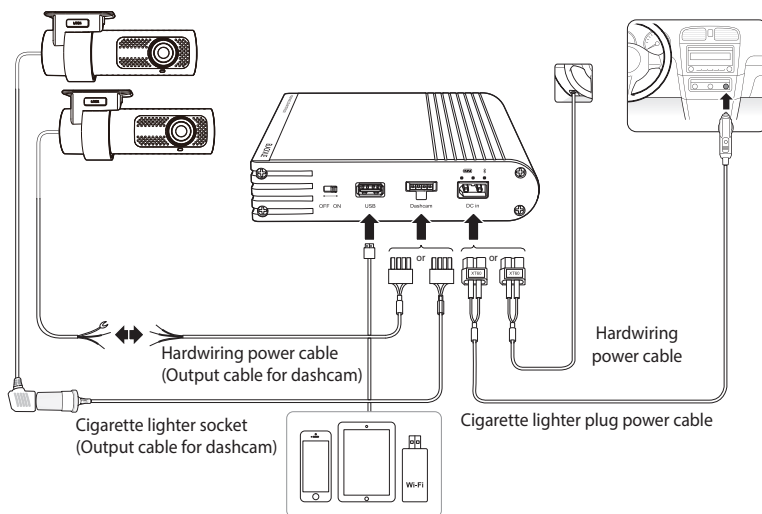

## ▶ Safety instructions

Incorrect use of the Power Magic Ultra Battery can lead to poor performance and may cause overheating, ignition, explosion, etc. To use the product correctly please observe the following directions:

- Familiarize yourself with the contents of the user manual before using the product.
- Only use original BlackVue cables provided by the manufacturer. For replacements contact customer support or your nearest distributor.
- Only use the product to power a dashcam.
- Do not expose the product to direct sunlight or heat.
- Do not expose to high temperatures.
- Do not use a cigarette lighter multi-socket splitter (adapter) with the product.
- Do not put the product in a microwave oven or place it in a high-pressure environment.
- Do not repair or modify the product yourself.
- Do not throw the battery or subject it to any physical shock.
- Do not disassemble, compress or puncture the product.
- Do not use the product in an electrostatic environment as it can affect the operation of the battery protection circuitry.

- If the product emits an unusual odor during use, unplug it immediately and contact customer support or your nearest distributor.
- If the battery swells up, immediately discontinue using the product. Contact customer support or your nearest distributor.
- Keep the product away from children and pets.
- Do not allow metal objects to contact the terminals of the power and output cables.
- Ensure the battery does not come into contact with water or other liquids.
- Pittasoft Co., Ltd. is not liable for damage resulting from disassembling, opening or modifying the product.

## ➤ Disposal of your battery pack

1. All electrical and electronic products should be disposed of separately from the municipal waste stream via designated collection facilities appointed by the government or the local authorities. Contact local authorities to learn about disposal and recycling options available in your area.
2. Do not incinerate or expose to fire. Exposure to excess heat may result in fire or an explosion.

## ➤ Components

Check the box for each of the following items before installing the Power Magic Ultra Battery B-130X.



Power Magic Ultra  
Battery B-130X



User Manual



Cigarette lighter plug power  
cable

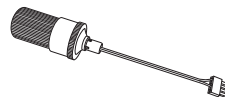

Output cable for dashcam  
(Cigarette lighter socket)



Hardwiring power cable

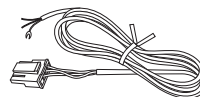

Output cable for dashcam  
(Hardwiring power cable)

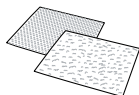

Velcro strips (2 EA)

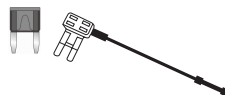





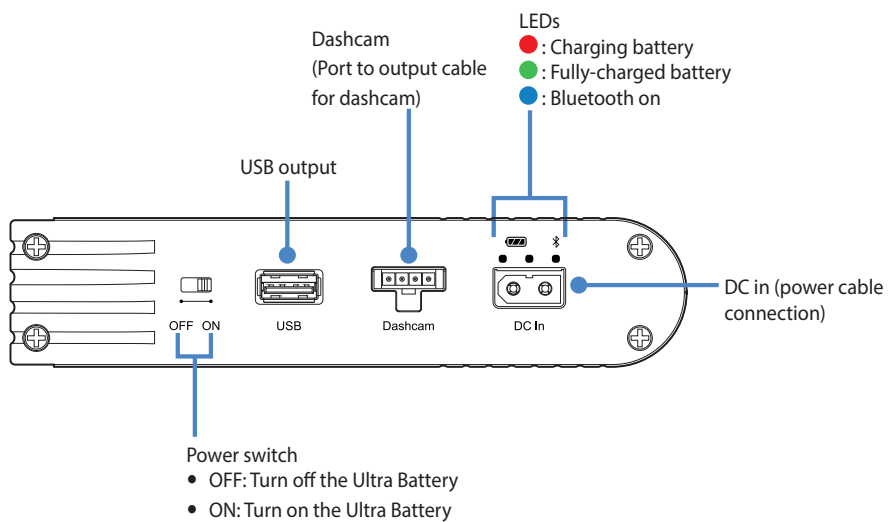
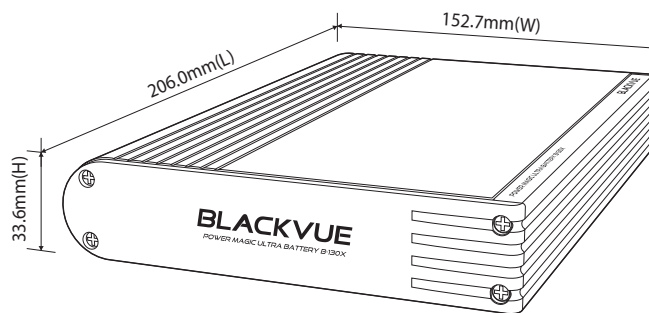















Fuse tap kit (3 types)

## At a glance



## LED indicators and beeps

	LEDs	Sound alert	
Powered on	  	All 3 LEDs turn on together and then turn off one by one.	Welcome chime
Started charging	  	Red LED blinks for 5 seconds	Beeps once
Charging	  	Red LED is on	
Fully charged	  	Green LED is on	
Bluetooth connected	  	Blue LED is on	
Low input voltage warning/High input voltage warning	  	Red and Green LED blink together	Beeps twice (Repeated)
Overheated warning	  	Red LED and Green LED blink one after another	Beeps twice (Repeated)

\* Beeping can be activated over Bluetooth using the BlackVue app.

\* Welcome chime and beeping sound for overheated warning cannot be muted for safety reasons.

## Product features

- Approximately 30 hours of power from 50 minutes of charging by hardwired installation / 90 minutes of charging by plug-in installation (based on a dashcam that uses 3 W).
- Compatible with 2 installation methods:
  - Plug-in installation: Simply plug-in cigarette lighter plug power cable (standard 5A charging); or
  - Hardwired installation: Connect the hardwiring power cable for faster charge (rapid 9 A charging).
- Configure settings via Bluetooth with the BlackVue app.
- Compatible with both car (12 V) and heavy vehicle (24 V) electrical systems.
- Battery protection circuitry for increased safety and extended battery life.
- Simultaneously charge your Ultra Battery and power your dashcam while driving.
- Power output automatically switches to draw power from the Ultra Battery when the engine is off.
- Battery cycle life: Designed to retain more than 80% of its original capacity at 1,500 complete charge/discharge cycles.
- Temperature Cut-off functions:
  - High Temperature: Shuts down the battery's charging power if the internal temperature reaches 80°C (176°F) or above.
  - Low Temperature: Shuts down the battery's charging power if the internal temperature reaches below 0°C (32°F).
- 1 USB port (5 V) allows you to simultaneously charge another device (smartphone, mobile Wi-Fi hotspot, etc.) while powering the dashcam.

## Installation guide

Set the power switch to the OFF position before installation.

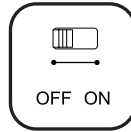

### Caution

Make sure to use the genuine power cables included in the package. Otherwise, it may result in product failure, overheating, ignition, etc.

#### 1. For a plug-in installation using a *cigarette lighter plug power cable*:

- Plug the *cigarette lighter plug power cable* into the Ultra Battery's **DC in** port. Plug the other end of the power cable into the vehicle's cigarette lighter socket.

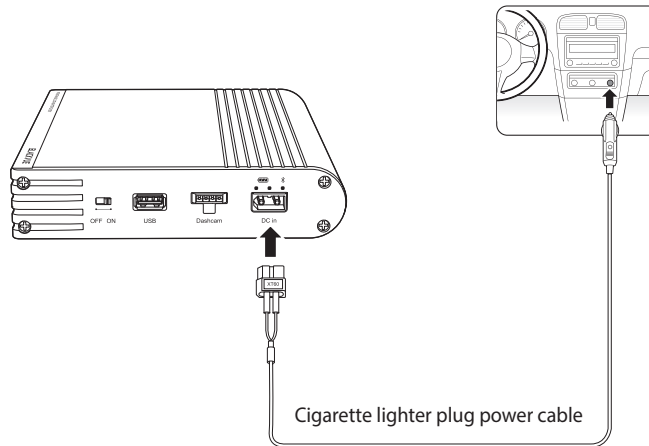

- Proceed to step 2.

or

#### 1. For a hardwired installation using a *hardwiring power cable*:

- Plug the *hardwiring power cable* into the Ultra Battery's **DC in** port.



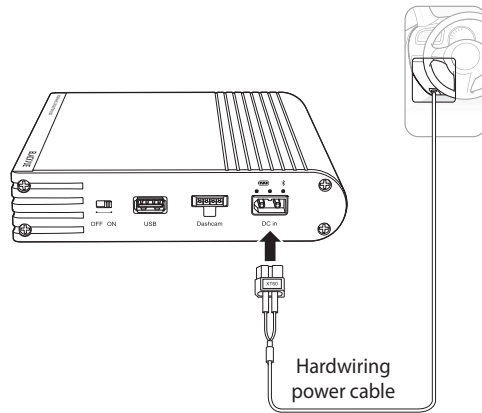

- b. Referring to your vehicle Owner's Manual, identify a **Switched** (accessory power) fuse of 10A or less in your interior fuse panel. Typical examples are the cigarette lighter and car stereo fuse slots.

**Caution**

If you connect the Ultra Battery to a **Constant Power** (BATT) fuse it may result in depletion of your vehicle's battery.

- c. Remove the identified **Switched** fuse and match its type with one of the 3 fuse taps.
- d. Insert the **ACC** wire into the connector end of the fuse tap. Use a crimping tool or pliers to crimp the connector onto the wire.

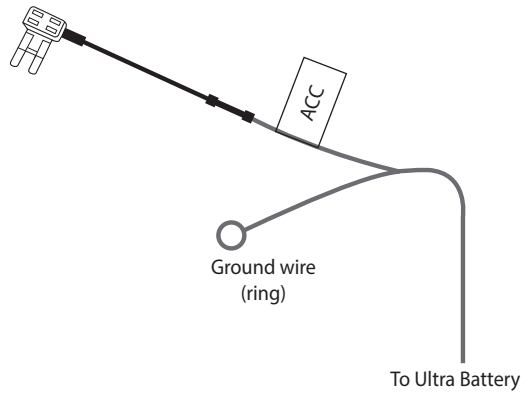

e. Insert the fuse you removed from the fuse panel into the slot closest to the blades on the fuse tap.



**Note**

If the original fuse is a low-profile mini type, use the new 10A mini type fuse instead (included).

f. Insert a new 20A fuse into the slot furthest away from the fuse tap blades.

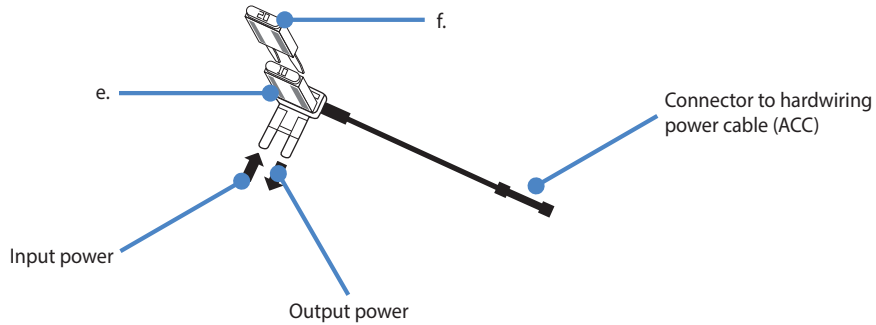

g. Insert the fuse tap into the empty **Switched** fuse slot in the fuse panel.



**Caution**

Refer to the diagram and insert the fuse tap in the correct orientation. In the correct orientation the new fuse (f.) gets power directly from the fuse slot without putting an additional load on the original fuse (e.). If you insert the fuse tap in the reversed orientation the additional load on the original fuse may cause it to blow.

h. Connect the ground wire (ring) to a ground point, such as a bolt, that is directly on a bare metal part of the vehicle's frame. Secure the ground wire to the bare metal frame (for example by securing it under the bolt).

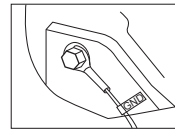

2. Plug the 'Output cable' into the port labeled **Dashcam** on the Ultra Battery.

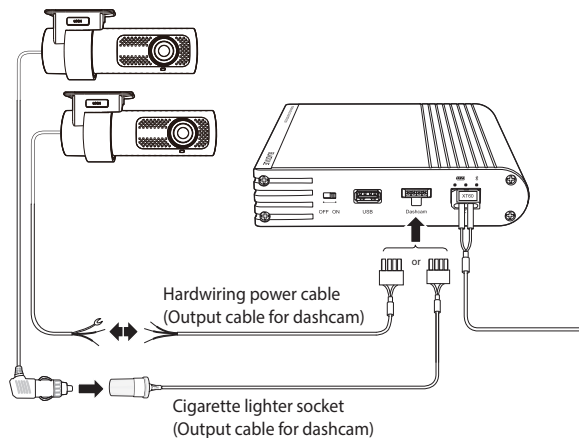

3. Plug your dashcam's power plug into the cigarette lighter socket or attach it to the hardwiring power cable on the Ultra Battery's 'Output cable.'

**Note**

To ensure good electrical contact you can use electrical tape to tape the plug and socket together.

4. Set the power switch to the ON position.
5. Use a pry tool to lift the edges of the windshield trim/molding and tuck in the power cord. Use the supplied Velcro strips to fix the Ultra Battery in place

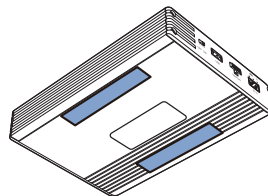
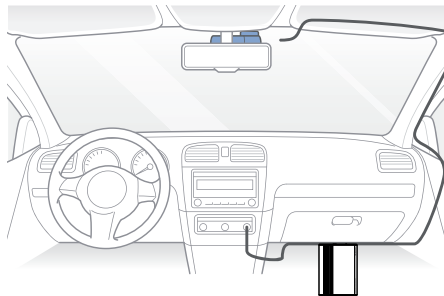

**Caution**

Do not expose the product to direct sunlight and/or heat.

## ▶ Checking the battery status and changing settings

1. Turn on the Ultra Battery.
2. Go to your smartphone's **Settings** and turn on **Bluetooth**.
3. Search for the **BlackVue app** in the Google Play Store or Apple App Store and install it on your smartphone. If you are not a BlackVue dashcam user, download **BlackVue Battery app** and skip to (B).

### (A) **Connecting Ultra battery to the BlackVue app (BlackVue dashcam user only)**

- a. Open the **BlackVue app** and tap **BlackVue Battery**.
- b. Select your Ultra Battery from the list. If your Ultra Battery is not shown in 15~20 seconds, **Rescan** button will appear. Tap it to refresh the list.

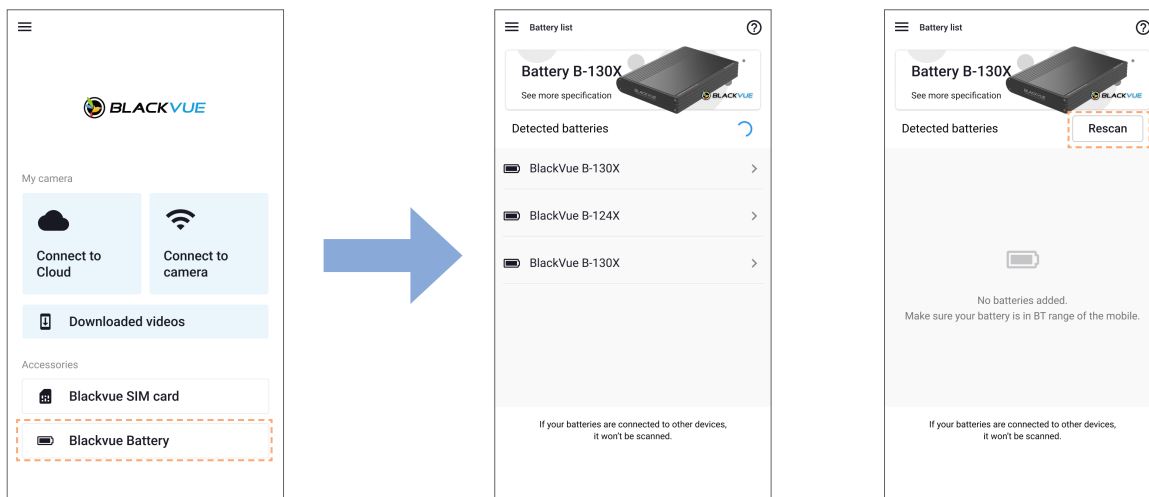

### Battery information screen

Settings

Battery's model name

Battery temperature

Remaining time: Estimated usage time (hours: mins) at the present power draw level

Device plugged into USB port\*

Battery power supply information (Input voltage/Power cable type)

Charging complete in: Estimated time to full charge (hours: mins) at the present power input level

Real-time current capacity percentage

Real-time output voltage and current

Real-time charging voltage and current

Current capacity	75%	Current capacity	50%
Output voltage	- V / - A	Charging voltage	13.7 V / 5.0 A
Charging voltage	- V / - A		

\* Some USB cables may not be detected

### Battery settings screen

Back/Save

settings

Beep On/Off

Turn beep alerts on or off

 **Caution**

- Under low temperature environment, the efficiency of Ultra battery's cell may decrease, however, this condition is temporary. Once the battery's temperature returns to its normal operating range, its efficiency will return to normal as well.

 **Note**

- All images shown are for illustration purpose only. Actual app may differ from images shown.

**B** ***Connecting Ultra battery to the BlackVue Battery app***

- a. Open the **BlackVue Battery app**.
- b. Select your Ultra Battery from the list. If your Ultra Battery is not shown, tap **Scan** to refresh the list.
  - A sticker with the unique Bluetooth ID is attached to each Ultra Battery.

## Product specifications

<b>Model</b>	Power Magic Ultra Battery B-130X
<b>Color / Size / Weight</b>	Black / 152.7 mm (W) x 206.0 mm (L) x 33.6 mm (H) / 1,537 g
<b>Battery Cell Type</b>	LiFePO4
<b>Input Voltage / Current</b>	12V system: - Cigarette lighter plug: 11 V–18 V / 7.2 A (max) - Hardwired: 11 V–18 V / 13.0 A (max)
	24V system: - Cigarette lighter plug: 22.5 V–30 V / 3.6 A (max) - Hardwired: 22.5 V–30 V / 6.4 A (max)
<b>Charging Voltage / Current</b>	Cigarette lighter plug: 14.2 V / 5 A Hardwired: 14.2 V / 9 A
<b>Charging Time</b>	Cigarette lighter plug (standard 5 A charging): Approx. 90 mins Hardwired (rapid 9 A charging): Approx. 50 mins
<b>Hours of Use</b>	Approx. 30 hours (based on a single dashcam that consumes 3 W)
<b>Operating Temperature</b>	Charging Temperature: 0°C – 45°C (32°F – 113°F)
	Discharging Temperature: -10°C – 60°C (14°F – 140°F)
<b>Storage Temperature</b>	-20°C – 45°C (-4°F – 113°F)
<b>Temperature Cut-Off</b>	High temperature: Approx. 80°C (176°F) / Low temperature: Below 0°C (32°F)
<b>Capacity</b>	12.8 V / 7,500 mAh / 96 Wh
<b>Output Voltage / Current</b>	Dashcam port: 11.0 V–14.2 V / 2 A (max)
	USB port: 4.75 V–5.2 V / 2 A (max)

## Customer Support

For customer support, manual and any updates please visit [www.blackvue.com](http://www.blackvue.com).

You can also email a Customer Support expert at [cs@pittasoft.com](mailto:cs@pittasoft.com).

## Limited Warranty

- The warranty period of this product is 1 year from the purchase date.
- If the product fails during normal and correct use within the warranty period, our service center will repair the product free of charge.
- Any disassembly, modification or alteration of the product will void the warranty.
- The cost to repair or fix any malfunction or problem caused by incorrect usage during the warranty period may be charged to the consumer.
- The manufacturer shall not be responsible or liable for any loss or damage caused by incorrectly using the product.

## ▶ BlackVue Power Magic Ultra Battery B-130X

차량의 배터리를 보호하면서 블랙박스의 주차모드를 장시간 사용할 수 있습니다.

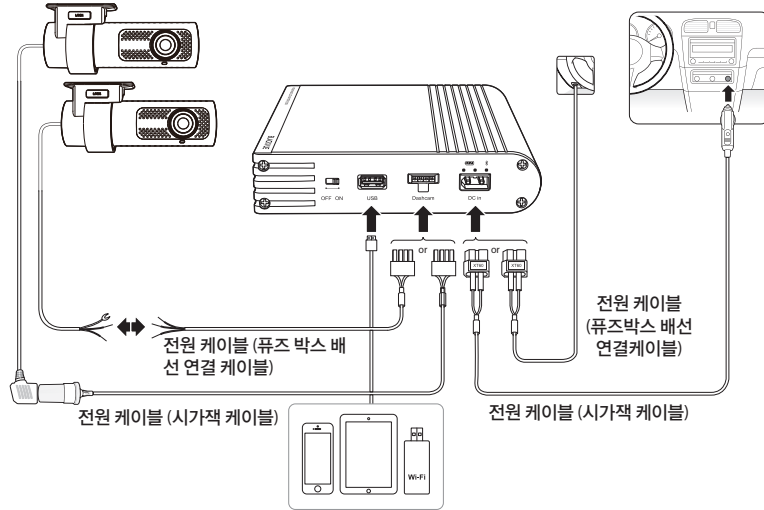

## ▶ 안전 정보

Power Magic Ultra Battery을 올바르게 사용하지 않으면 성능이 저하되고 과열, 화재, 폭발의 위험이 있습니다. 다음의 설명에 따라 제품을 올바르게 사용하십시오.

- 제품을 사용하기에 앞서 사용자 설명서의 내용을 숙지하십시오.
- 차량에 설치 시 제조사에서 제공한 정품 케이블만을 사용하십시오. 케이블 불량 시 당사 고객만족센터에 문의하십시오.
- 본 제품을 블랙박스 사용 목적 외의 다른 용도로 절대 사용하지 마십시오.
- 제품을 직사광선 또는 열에 노출시키지 마십시오.
- 온도가 높은 장소에 보관하지 마십시오.
- 다른 제품과 함께 차량용 멀티 소켓에 연결하여 사용하지 마십시오.
- 제품을 전자기인자나 압력이 높은 곳에 넣지 마십시오.
- 제품을 직접 수리하거나 개조하지 마십시오.
- 배터리를 던지거나 기타 강한 충격을 가하지 마십시오.
- 배터리를 분해하거나 압착 또는 날카로운 물건 등으로 구멍을 내지 마십시오.
- 배터리의 보호회로의 성능에 영향을 줄 수 있는 정전기 등이 발생할 수 있는 장소에서는 사용하지 마십시오.
- 사용 중 제품에서 이상한 냄새가 날 경우 사용을 중단하고 당사 고객만족센터에 문의하십시오.
- 배터리 사용 중 배부름 현상이 발견되면 사용하지 마시고 새 제품으로 교환하십시오.



- 아이들 또는 애완동물이 제품을 만지지 못하도록 하십시오.
- 배터리 충전케이블의 연결단자에 금속 등 도체성 물체가 닿지 않도록 주의하십시오.
- 배터리를 물 또는 기타 액체 등에 젖지 않도록 주의하십시오.
- (주)피타소프트는 제품 분해, 개조로 인해 발생하는 피해에 대해 어떠한 책임도 지지 않습니다.

### ▶ 배터리 폐기 지침

1. 다 쓴 배터리는 함부로 버리지 마세요.  
배터리 폐기 방법은 나라 및 지역에 따라 다를 수 있으므로, 각 국가 또는 지역의 규정에서 지정한 수거 시설을 통해 처리하시기 바랍니다.
2. 배터리를 폐기할 경우 소각 및 불속에 넣지 마십시오. 열로 인해 폭발 및 화재가 발생할 수 있습니다.

### ▶ 패키지 구성품

Power Magic Ultra Battery B-130X을 설치하기에 앞서 구성품을 확인하여 주시기 바랍니다.

	<p>Power Magic Ultra Battery B-130X</p>		<p>사용자 설명서</p>
	<p>전원 케이블 (시가잭 케이블)</p>		<p>블랙박스 연결케이블 (시가소켓 케이블)</p>
	<p>전원 케이블 (퓨즈박스 배선 연결 케이블)</p>		<p>블랙박스 연결케이블 (상시 전원 케이블)</p>
	<p>벨크로 테이프 (2개)</p>		<p>퓨즈탭 (3가지 종류)</p>

## ▶ Pewer Magic Ultra Battery B-130X 살펴보기

