

# COMFAST 3000Mbps WiFi 6 Repeater User Manual

## Manualsum, simplified manuals

### Table of Contents

- [COMFAST 3000Mbps WiFi 6 Repeater User Manual](#)
  - [Introduction](#)
    - [Product Structure:](#)
  - [Relay installation steps](#)
    - ■ ■ [Illustrate](#)
  - [Introduction to working mode](#)
  - [IPv6 Setting](#)
  - [Mesh Setting](#)
    - [Precautions:](#)
    - [EasyMesh settings:](#)
    - [Mesh pairing:](#)
  - [Light control status](#)
  - [FAQ](#)
  - [Maintenance Regulations](#)
  - [Quick Installation Guide](#)

# COMFAST 3000Mbps WiFi 6 Repeater User Manual

COMFAST 3000Mbps WiFi 6 Repeater User Manual

RADIOSHACK WORLDWIDE 3000Mbps WiFi6 Repeater User Manual

FCC id: [2BDUR-2505010](#)

# COMFAST

# Introduction

## Product Structure:

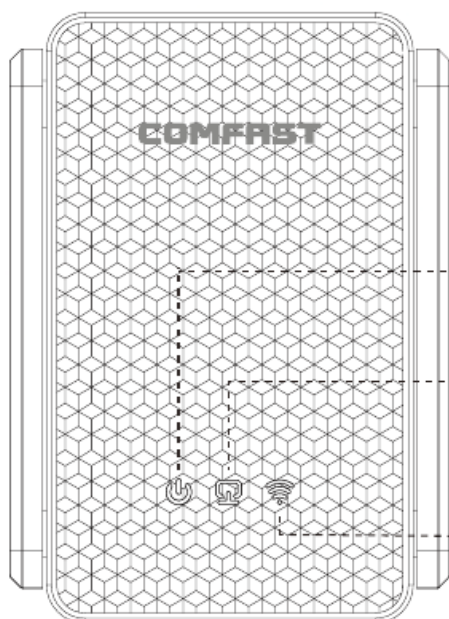

### Power indicator:

Blue is always on to indicate the power is on

### Network port status light:

Blue is always on to indicate normal network cable access

### WiFi status light:

Steady red indicates that the trunk signal is weak

Steady blue indicates that the trunk signal is strong

Steady green indicates that the device is connected to WiFi

## LAN/WAN

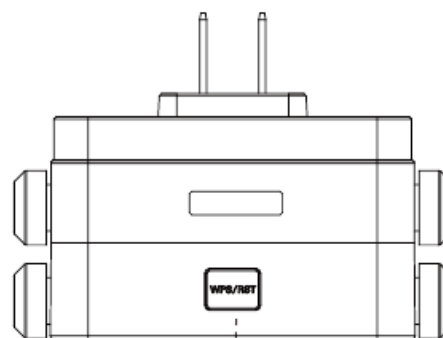
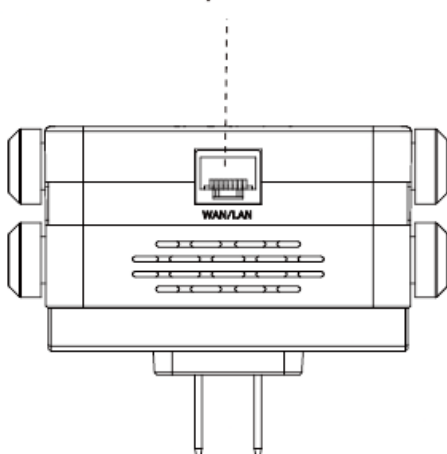

## WPS/RESET

**Tip:** Hold down the RESET key for 5 seconds to reset the device

## Relay installation steps

1. Plug in the power supply, wait for 1-2 minutes, and connect to WiFi "COMFAST\_XXXX\_2G" or "COMFAST\_XXXX\_5G"

2. Click the WiFi signal “COMFAST\_XXXX\_2G” or “COMFAST\_XXXX\_5G” to pop up the login interface, enter the password “admin” in the password box, and click “Set Password”.

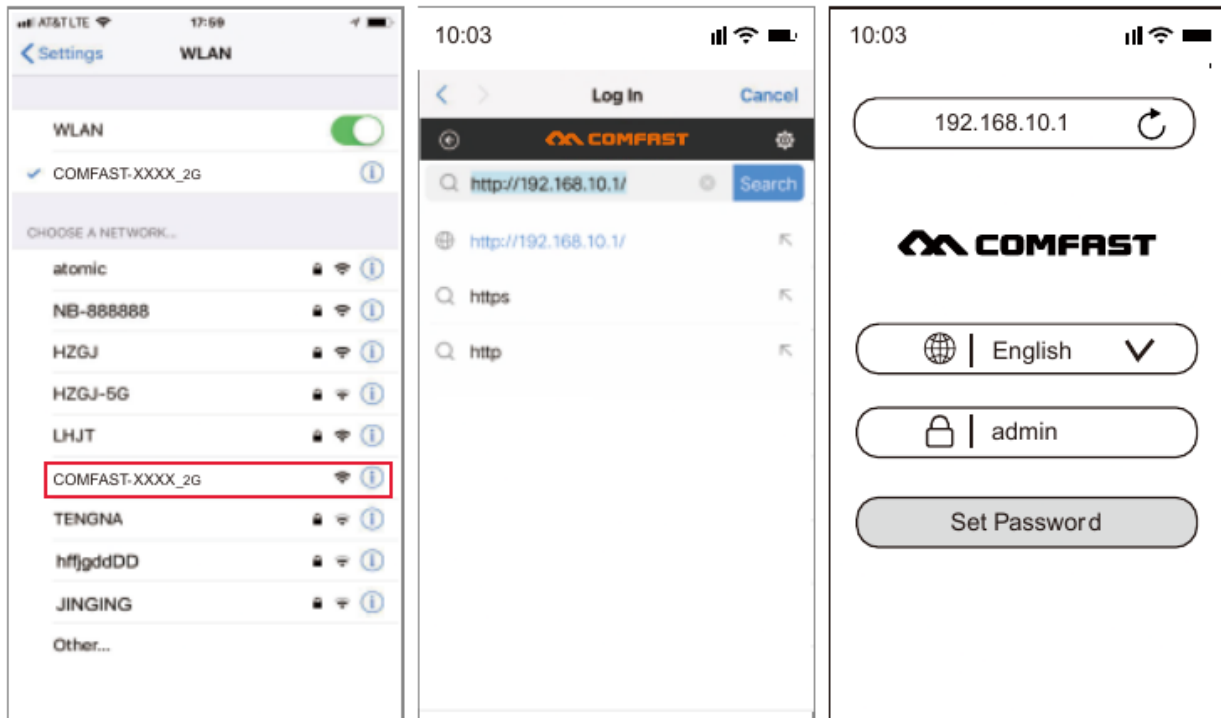

**Tip:** When logging in for the first time, the login interface will pop up automatically. There are two cases when there is no login interface:

First, the mobile phone itself does not support pop-up windows; Second, once set, once again enter the interface, you need to manually, Manual entry method: Open the mobile phone browser, enter “192.168.10.1” in the address bar.

1. After setting the password for the first time, it will automatically enter the repeater scanning page. Set the trunk then choose SSID of the repeater, enter the upper routing password and click Save to complete the repeater, reconnect to the wireless network to access the Internet, the wireless password is the superior routing password (the expanded signal will be in the superior Add “-2G / 5G” suffix such as XXXX-2G / 5G after the WiFi name.

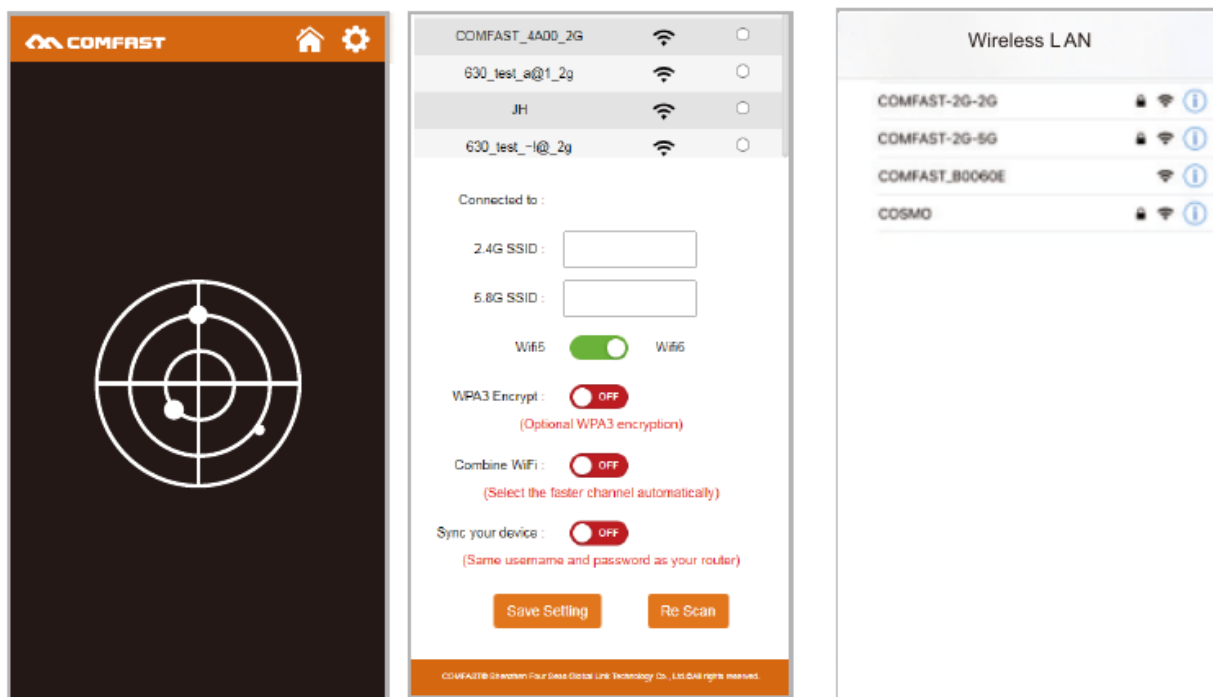

## Illustrate

**WiFi5/WiFi6 switch:** The repeater selects WiFi5 or WiFi6 protocol, the default is WiFi6.

**WPA3 encryption:** When this option is turned on, the repeater uses WPA2/WPA3 hybrid encryption.

**Combine WiFi:** Turn this option on, it merges 2G and 5G signals into one SSID, and only shows the SIDD name after one relay in the list box.

**Sync your device:** Turn on this option, the new WiFi name will be the same as your original WiFi name, no need to reset the extended WiFi name.

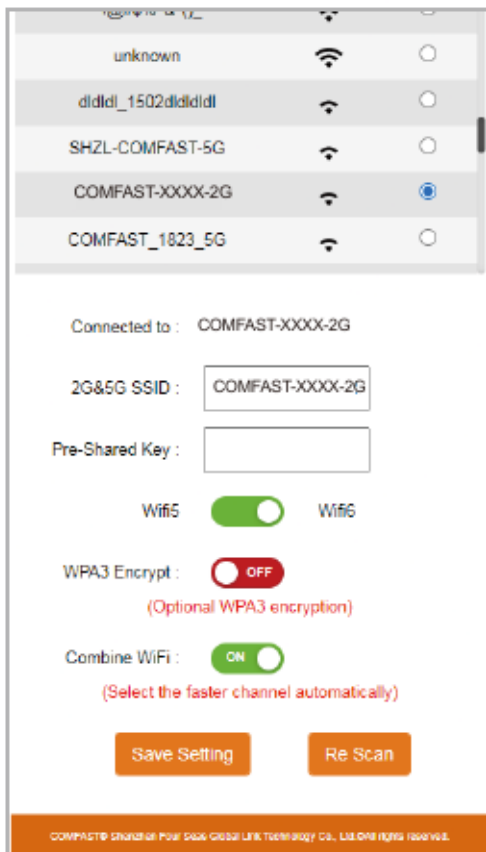

## Introduction to working mode

1. The software has four working modes, including relay mode, bridge mode, AP mode, routing mode (PPPoE dial-up, static IP, dynamic IP).
2. Bridge mode settings: Find and set in Advanced Mode .
3. AP mode setting: Enter the software management page, click AP mode, in order to facilitate management, the IP address and default gateway entered here should be the IP network segment of the upper-level router, and the IP address cannot conflict with the IP of the upper-level router. After the setting is completed, the WAN port of the device is connected to the external network, and the management device can be accessed through the set IP address. (DNote: When accessing the external network in AP mode, the IP address network segment obtained wirelessly by other mobile devices accessing the AP is allocated by the upper-level device. (According to the default settings, it is also possible not to set the specific intranet IP address of the device; if you need to manage the device, you must manually set the IP address of the computer's local connection network card.
4. AP mode, you can set 2.4G/5.8G wireless SSID name and password. After setting, the WAN port of the device is connected to the external network; other mobile devices can connect to the Internet by wirelessly connecting to the SSID name of the device and entering the password.

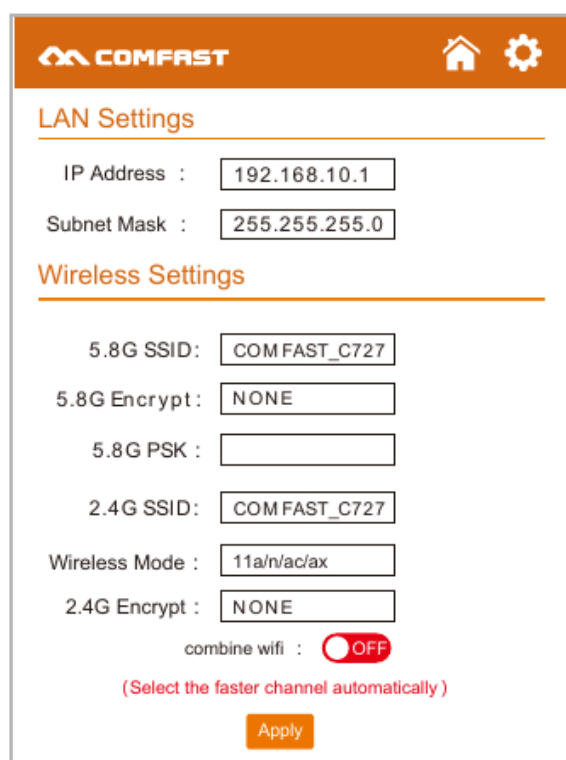
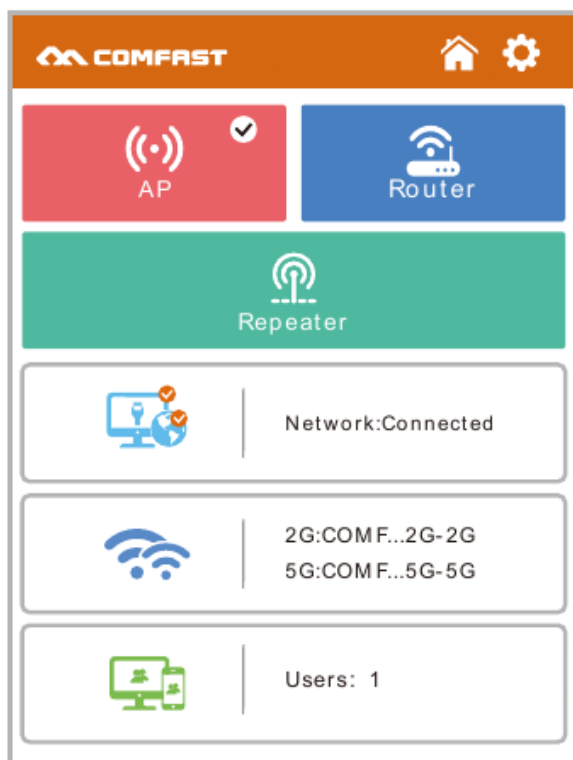

5. Routing mode setting: Enter the software management page, only the routing mode is displayed, click the routing mode, and you can choose three Internet access modes: “PPPoE”, “Static IP” and “Dynamic IP”.

1. PPPOE dial-up mode: In this mode, you need to fill in the Internet account and password provided by the network service provider. The 2.4G/5.8G wireless SSID name and wireless password can be set below.
2. Static IP mode: In this mode, you need to fill in the IP address, subnet mask, gateway, and primary DNS address provided by the network service provider. The 2.4G/5.8G wireless SSID name and wireless password can be set below.
3. Dynamic IP mode: In this mode, the WAN port can only access the Internet by assigning IP to the upper-level network device. The 2.4G/5.8G wireless SSID name can be set below.
4. IPV6 setting: Support DHCPV6 client, static IP and Relay function, the DHCPVE client function is enabled by default.

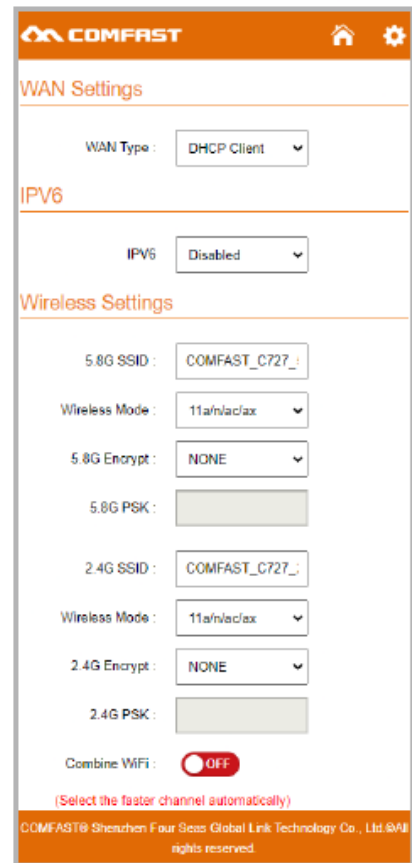
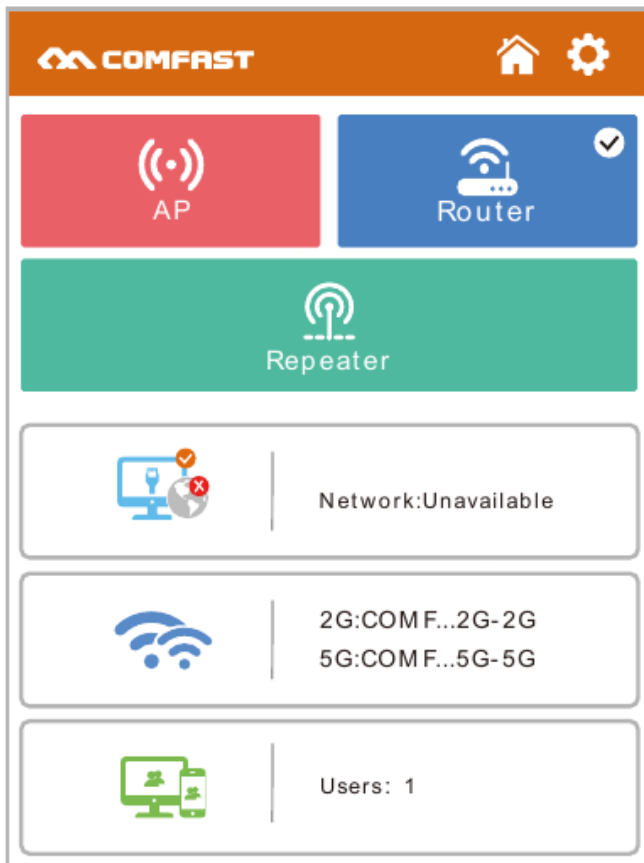

## IPv6 Setting

Click  and select to enter the  IPv6 setting page. IPv6 Status:  
Displays the information about the IPV6 address obtained by the device.

IPv6 Setting: Set the IPV6 LAN and WAN information.

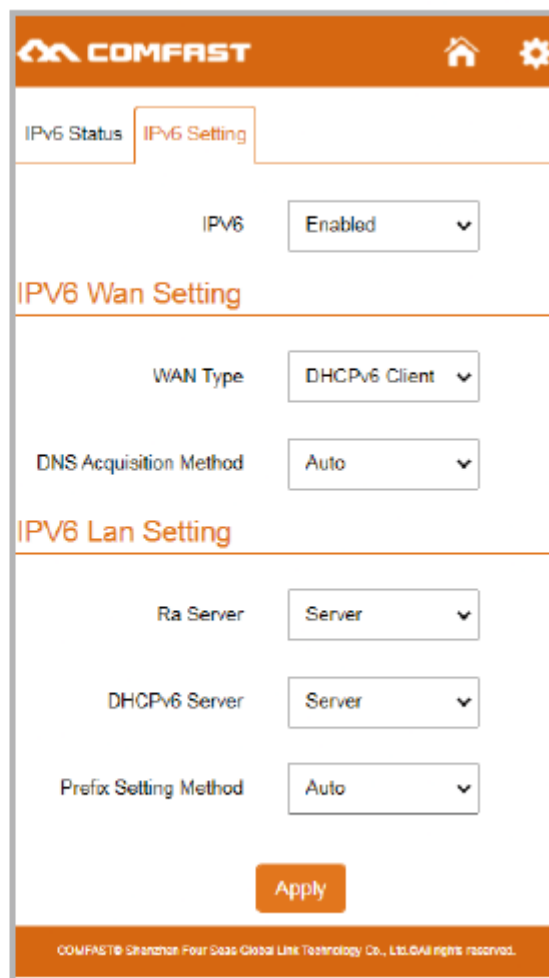
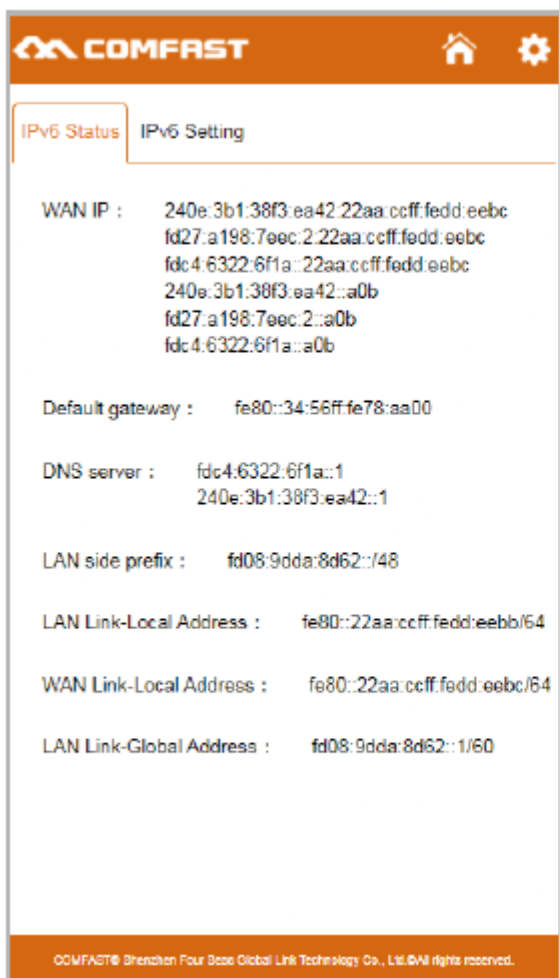

## Mesh Setting

### Precautions:

1. The Mesh controller node needs to be enabled in Router mode or AP mode. It is recommended to use it in Router mode.
2. The Mesh network consists of a management node and at least one agent node.
3. After enabling Mesh, you need to click the “Trigger EasyMesh” button on the two node pages to pair Mesh.
4. The Mesh pairing process takes about 2 minutes. After 2 minutes, go to the management node page, you can view the status of Mesh.
5. If the Mesh is not formed successfully. Try pairing again after clicking the “Restore EasyMesh to Default” button on the Mesh settings page.

Click  and select Enter to enter the  IPv6 Mesh setting page.

EasyMesh status: After the Mesh is successfully formed, view the schematic diagram of the Mesh.



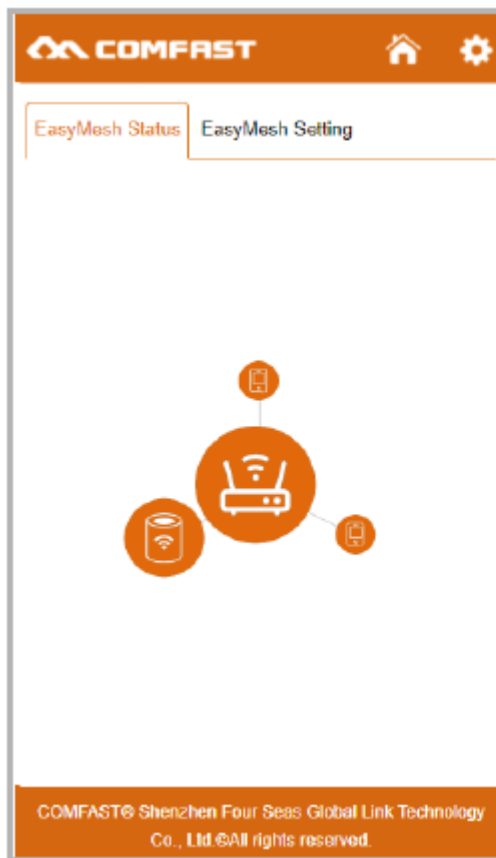

## EasyMesh settings:

1. Select the role of Mesh.
2. If you choose the role as “Controller”, you need to set the SSID and password of the Mesh.

Click “Settings” to save the configuration and enable the Mesh function.

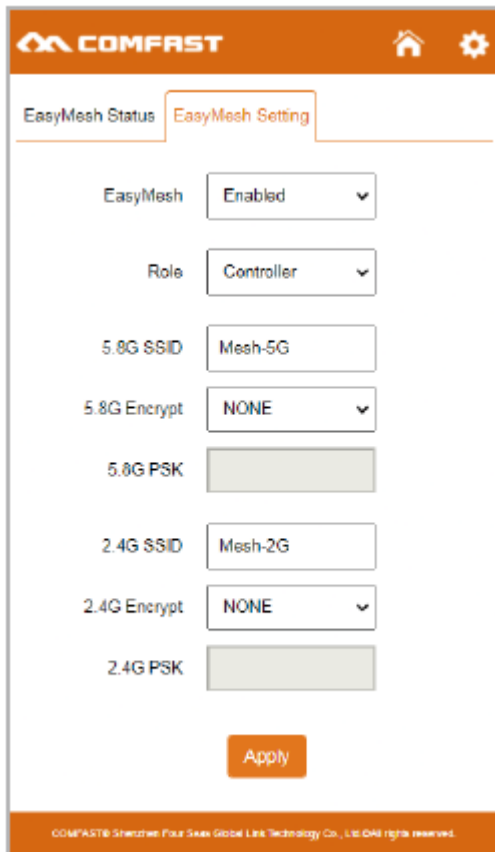

COMFAST

EasyMesh Status EasyMesh Setting

EasyMesh Enabled

Role Controller

5.8G SSID Mesh-5G

5.8G Encrypt NONE

5.8G PSK

2.4G SSID Mesh-2G

2.4G Encrypt NONE

2.4G PSK

Apply

COMFAST © Shenzhen Four Seas Global Link Technology Co., Ltd. All rights reserved.

## Mesh pairing:

After enabling Mesh, a button for Mesh pairing will appear on the page.

On the pages of the two nodes, click the “Trigger easymesh” button to start building Mesh.

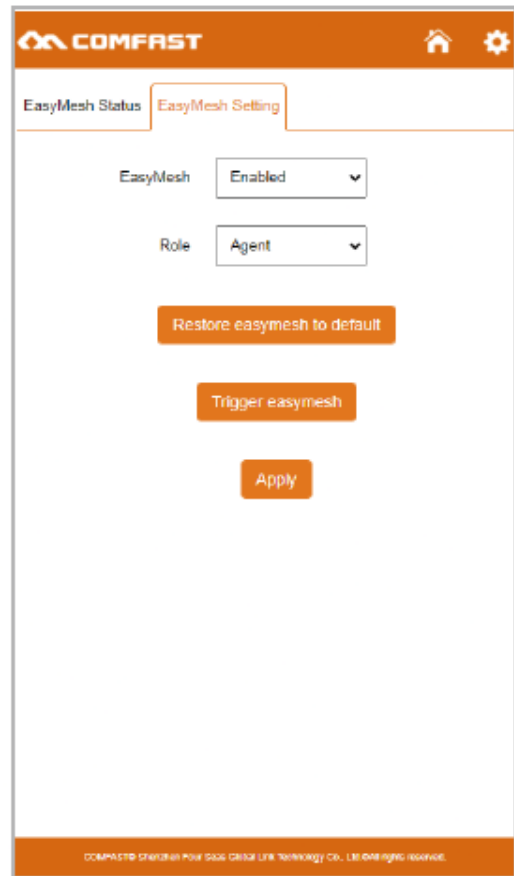
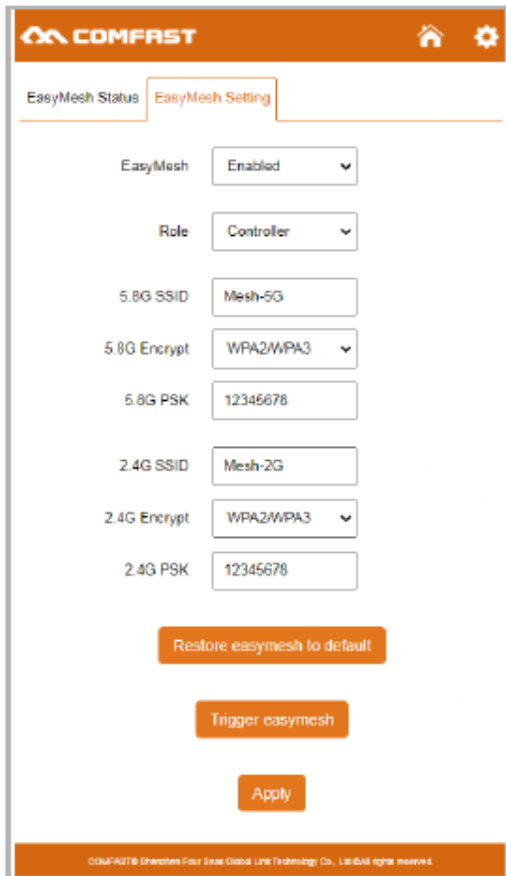

## Light control status

You can turn off the lights in advanced settings. NOTE: The power light cannot be turned off.

	AP/Route Mode	Trunk/Bridge Mode
Power light	Always bright	Always bright
Network cable light	Always bright	Connect to the network cable light on, unplug the network cable light off After successfully connecting to the superior, the corresponding signal will be displayed.
WiFi status light	Blue light is always on	Blue light: strong signal Green light: Normal signal Red light: weak signal

## FAQ

**Q: What's the role of WiFi extender?**

A: Boost the range of your existing WiFi and creates stronger signal in hard-to-reach areas. Please note that it can't increase your wifi speed of your router, the speed of the extending wifi will be reduced.

**Q: Where shall I place the WiFi extender?**

A: We would suggest that after setting up successfully, please move this wifi extender on the halfway between your router and your weak signal area. The location that you choose must be within the range of your existing WiFi router network.

**Q: How to reset the WiFi extender?**

A: Press the WPS/Reset button of your extender for 10 seconds, wait to restore factory settings, when the lamp is off and then light up again, you can begin to set up it again.

**Q: Why does WiFi keep disconnecting?**

A: We recommend resetting the WiFi extender. For more questions, please visit [www.szcomfast.com](http://www.szcomfast.com) official website

## Maintenance Regulations

Dear Valued Clients,

Thank you for purchasing a **COMFAST** products and service to protect your rights, please read the following maintenance regulations.

The following does not belong to free maintenance ,our company can provide paid service ,please note:

- Failure to require the installation manual , use ,maintenance, storage lead to product failure or damage;
- Beyond the limited warranty , the warranty period; Unauthorized alteration, tearing up the product bar code;
- Without authorization to change the settings file or inherent disassemble without authorization;
- Unexpected factors or human actions lead to product damage, such as improper input voltage, temperature,water mechanical damage, break, rust or serious oxidation of product etc;
- Other non-product itself, design ,technology,manufacturing, quality and other quality problems caused by the failure damage.



## Quick Installation Guide

### Statement

**Shenzhen Four Seas Global Link Network**

**Technology CO.,Ltd. all rights reserved.**

Without our official written permission, no unit or individual shall be copied, reproduced, transcribed or translated in part or whole book. In any form or by any means (electronic, mechanical, printing, recording or other possible means) or for the propagation of goods any commercial, profitable purposes.

**COMFAST** is the registered trademark of Shenzhen Four Seas Global Link Network Technology Co.,Ltd. All other trademarks or registered trademarks mentioned in this document, by respective owners.

Product specifications and information mentioned in this manual are for reference on subject to updates without notice. Unless there are other special agreements, this manual is used only as a user guide. All statements, information, etc. do not constitute any form of guarantee.

Manufacturer: Shenzhen Four Seas Global Link Network  
Technology Co.,Ltd.

Address: Room 607-610, Block B Tao JINDI Electronic  
Business Incubation Base, Tenglong Road, Longhua  
District, Shenzhen, China

Hotline: 4009-001-766

Website: [www.comfast.cn](http://www.comfast.cn) / [www.szcomfast.com](http://www.szcomfast.com)

COMFAST 3000Mbps WiFi 6 Repeater User Manual

[Manualsum](#)