

# **SHENZHEN AMEDIA** **TECHNOLOGY Smart TV Box** **User Manual**

## **Manualsum, simplified manuals**

### Table of Contents

- [SHENZHEN AMEDIA TECHNOLOGY Smart TV Box User Manual](#)
  - [Package Contents](#)
  - [Connection Diagram](#)
  - [Installation Steps](#)
  - [Multi-screen Interaction](#)
  - [The Screen Casting](#)
  - [Key Features](#)

## **SHENZHEN AMEDIA TECHNOLOGY** **Smart TV Box User Manual**

SHENZHEN AMEDIA TECHNOLOGY Smart TV Box User Manual

[2A6T2-X98K](#)

### **Package Contents**



[Manualsum](#)

Device x1

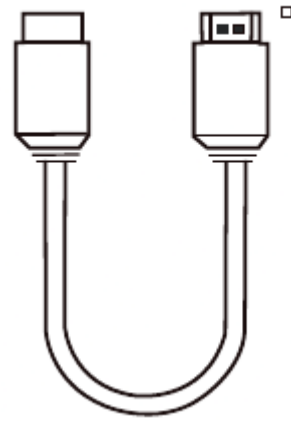

HD Cable x1

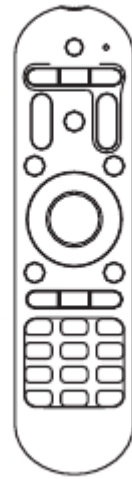

Remote Control  
x1



Power Adapt

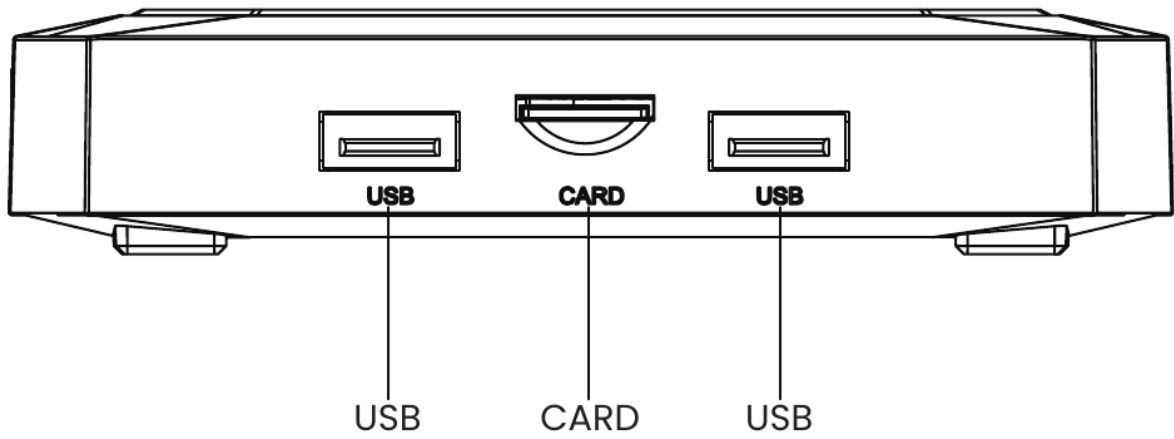

# Connection Diagram

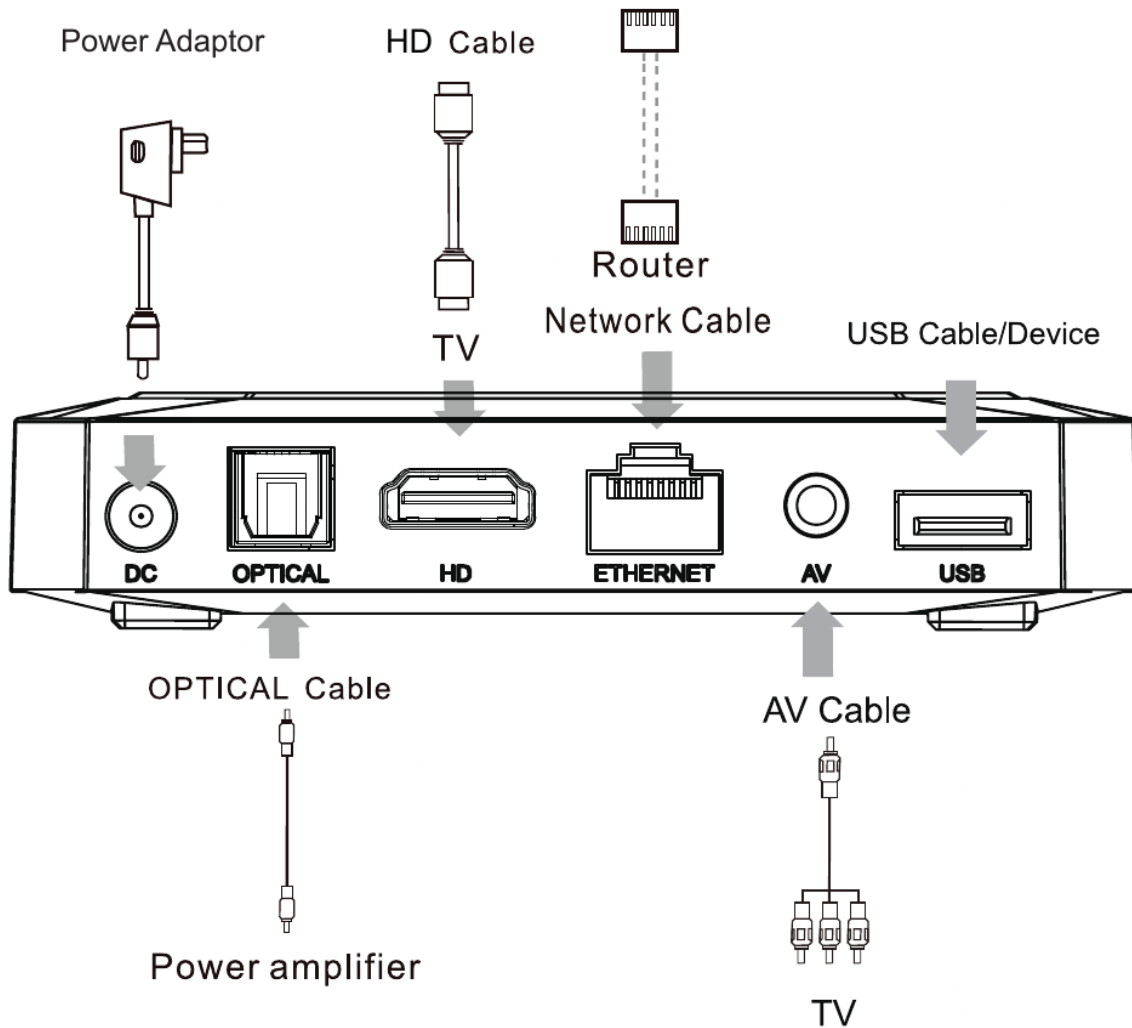

## Installation Steps

1. Connect the TV Box with the power supply.
2. Connect the TV Box to your TV with HD cable or AV cable.
3. For wired connection, plug in Ethernet cable from the TV Box to your modem or router. For wireless, choose your Wi-Fi network and input the password.

# Multi-screen Interaction

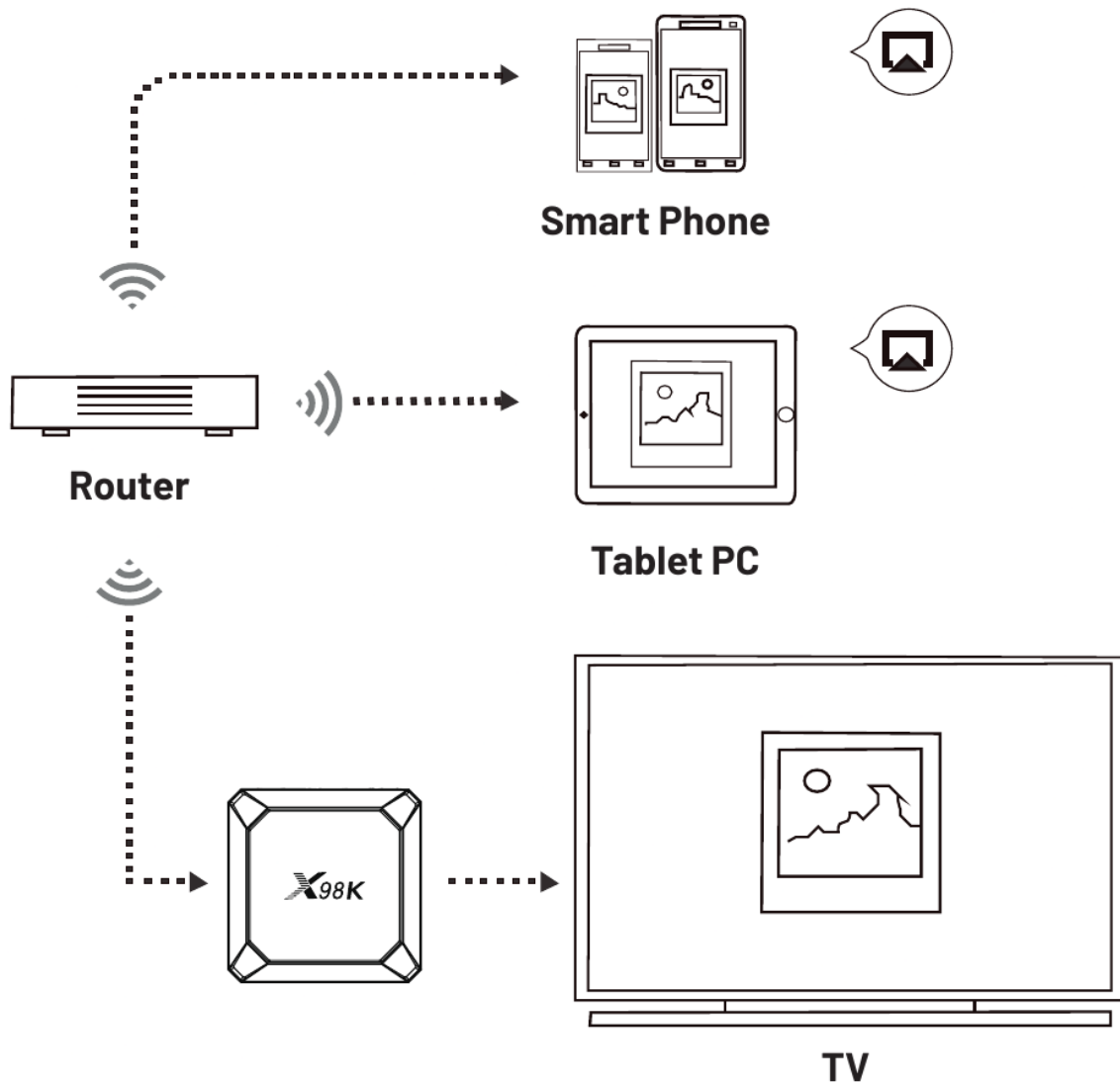

## The Screen Casting

### Introduction:

The TV Box lets you play photos, music, and videos from your smart phone or tablet computer on your TV.

### Preparation:

Make sure your device (s) and TV Box are connected to the same network.

### How to use:

After your device(s) and TV Box are connected to the same network, the

logo  will show up in the related applications of your device(s). Click

the  and share the photos, music and videos on TV.

## Key Features



CPU:Quad Core ARM Cortex A53

GPU:Mali-450



1. H.264/ AVC BP/MP/HP profile@ level 5.1; H.264/AVC MVC; up to 4Kx2K@ 60fps
2. H.265[HEVC Main/Main10 profile@ level 5.1 High-tier; up to 4Kx2K@ 60fps
3. AVS2 4Kx2K@60fps



RAM 2GB/4GB, 100/1000M Ethenet, 802.11a/b/g/n/ac 2.4G and 5G Wi-Fi, Support BT (option) .



Android 13 OS, OTA upgrade supported.

[Amedia Tech.](#)

[Manualsum](#)