

# Shenzhen Calion Power HELMET WIRELESS EARPHONE User Manual

## Manualsum, simplified manuals

### Table of Contents

- [Shenzhen Calion Power HELMET WIRELESS EARPHONE User Manual](#)
  - [Product overview](#)
    - ■ ■ [Important Notice:](#)
  - [Phone features](#)
    - [Power on/off](#)
    - [Paring](#)
    - [Lighting Lamp On/Off](#)
  - [Music features](#)
    - [Pause/Play music](#)
  - [Voice assistant](#)
  - [Charging mode](#)
  - [Catalogue of accessories](#)

# Shenzhen Calion Power HELMET WIRELESS EARPHONE User Manual

Shenzhen Calion Power HELMET WIRELESS EARPHONE User Manual

FCC id: [2AXEL-C8](#)

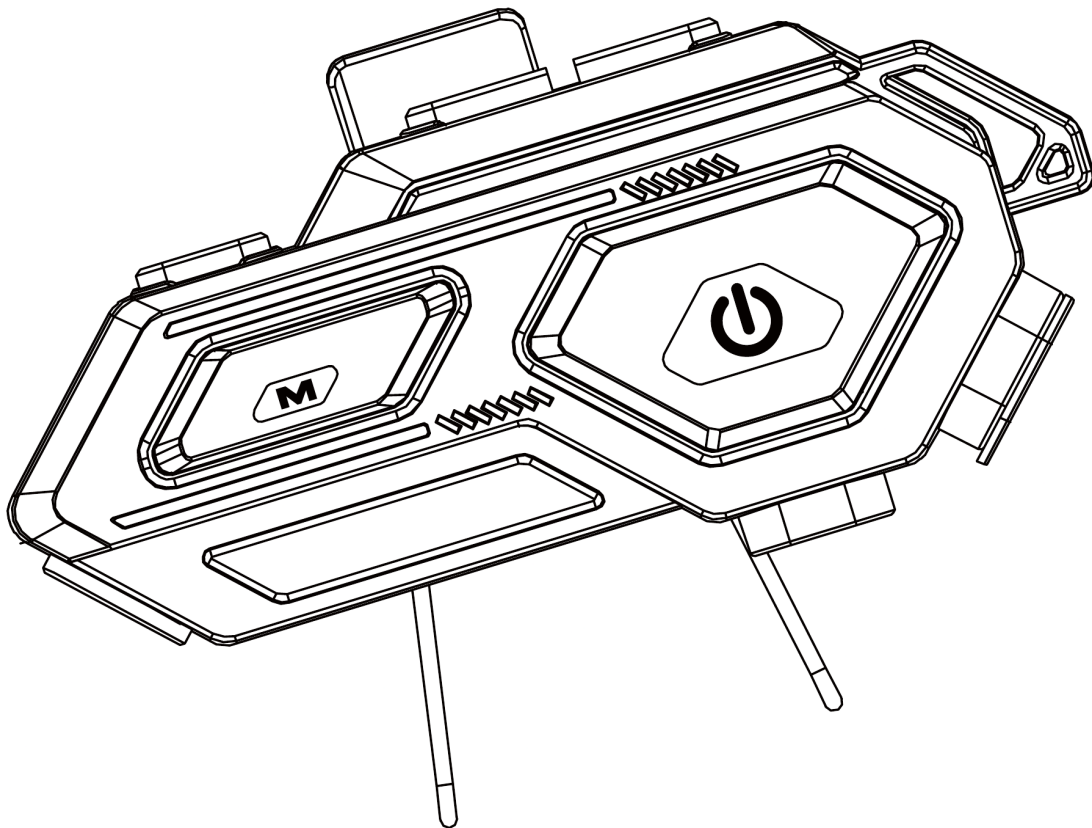

## Product overview

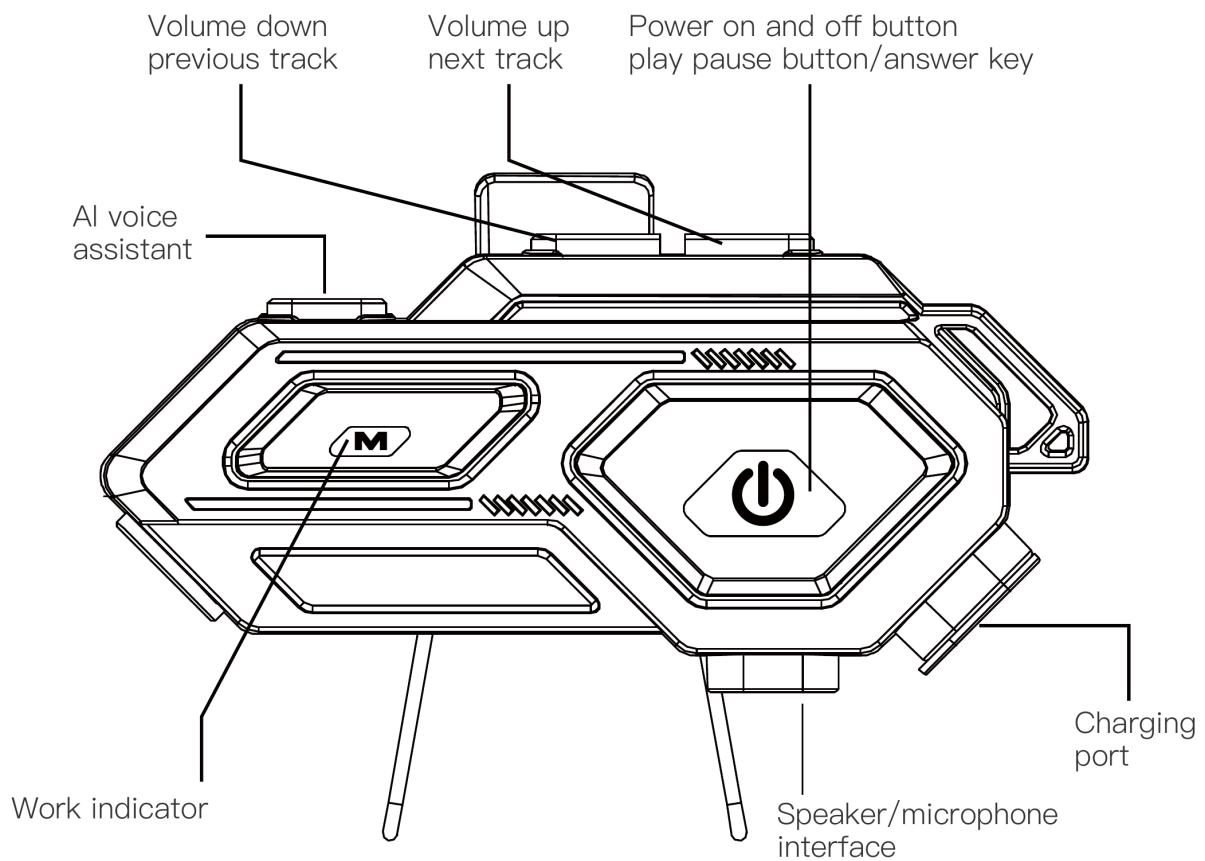

**Important Notice:**

**Before installation the headphones, please connect them to your phone and test the volume level. If you notice a significant difference in volume after installing them into the helmet, adjust the speakers to the appropriate position inside the helmet. When the battery is low, you'll hear a voice saying "Low Battery". Please charge the device promptly.**

## Phone features

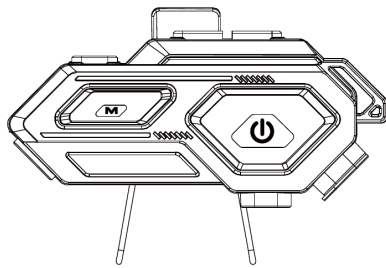

### Switch to answer

Automatic mode (Ⓞ wait 10 seconds and then answer automatically!)

→  
(When Bluetooth is not connected)

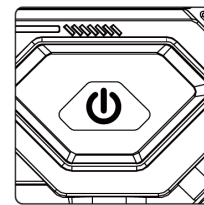

Double click on/off button to switch between manual answer and automatic answer

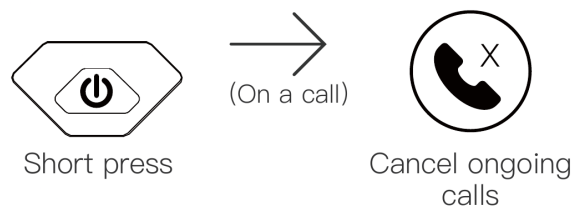
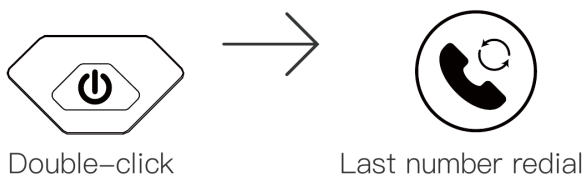
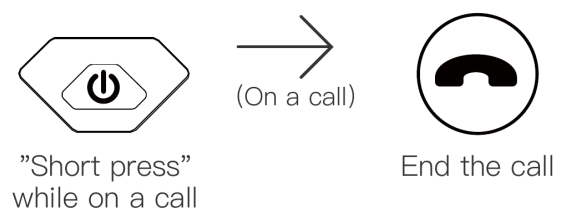
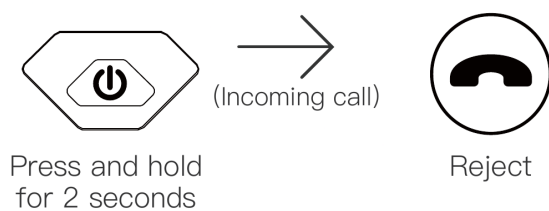
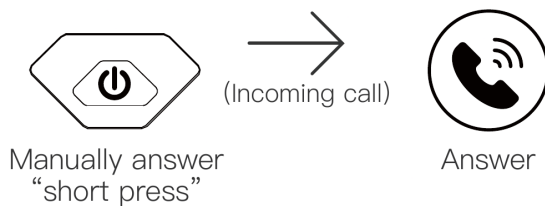
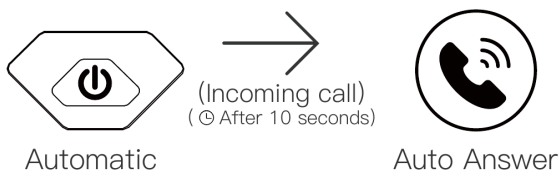

## Power on/off

”Triple tap to switch between Chinese and English voice (Bluetooth disconnected).”

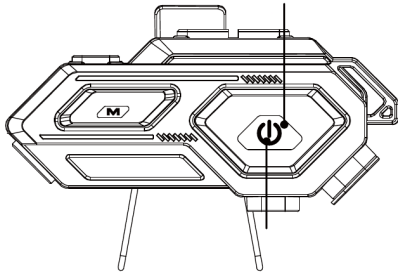

Press and hold for 3 seconds to turn on the device

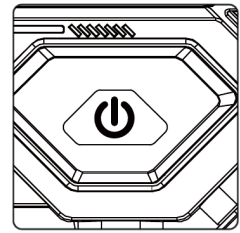
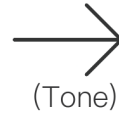

LED Lights on

## Paring

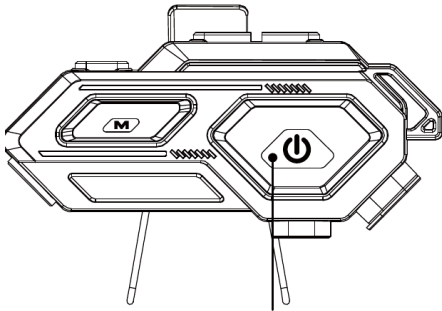

Bluetooth not connected  
LED flash

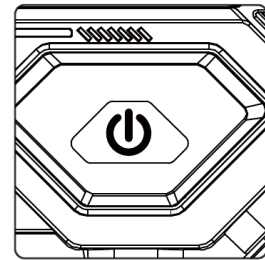
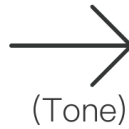

Bluetooth not connected  
LED Flash

## Lighting Lamp On/Off

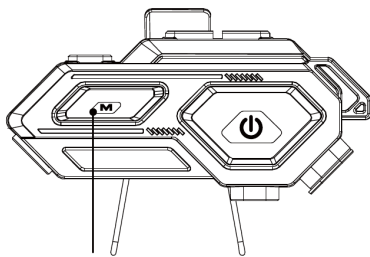

Double-click the M key to turn the lighting lamp on or off.

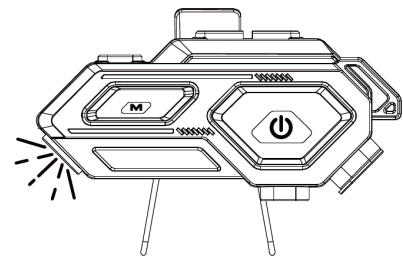

The light is on

# Music features

## Pause/Play music



Short Press

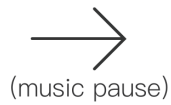

Play



Pause

Volume down key

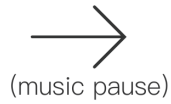
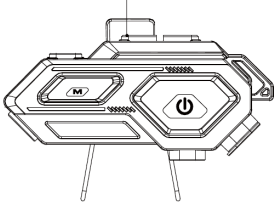

Short press for previous track

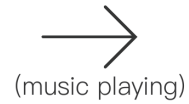

Long press to volume down

Volume up key

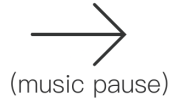
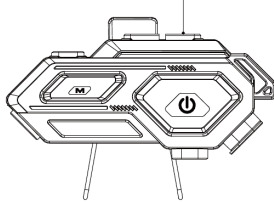

Short press for next track

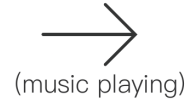

Long press to volume up

## Voice assistant

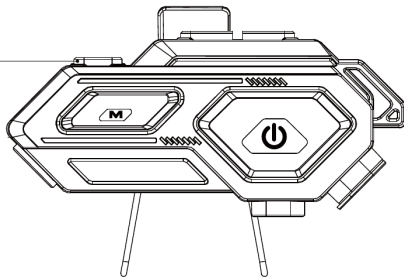

Voice Assistant Key

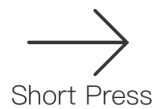

Wake up the voice assistant

## Charging mode

The light is on when charging

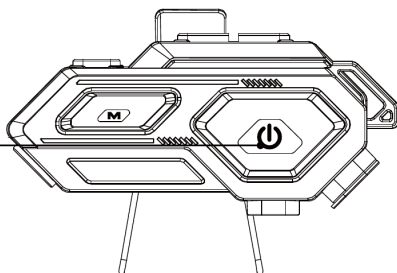

Fully charged, light off

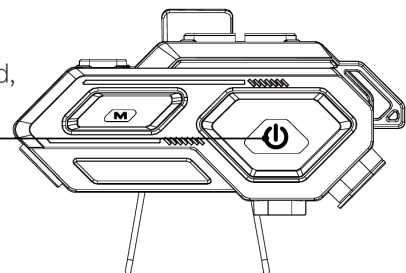

(When the device is on, plug in the Charger and the device will shut down automatically)

## Catalogue of accessories

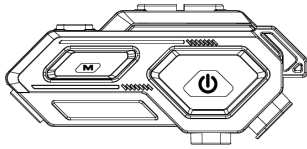

C8\*1

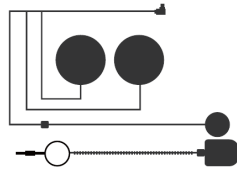

Headphones and  
Microphone\*1

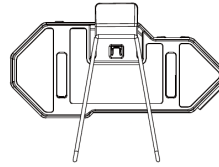

Clamping base\*1

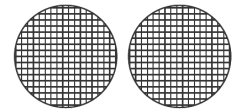

Microphone Velcro  
tape\*2

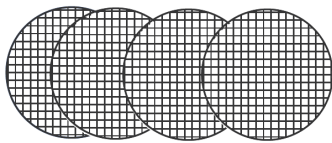

Speaker Velcro  
tape\*4

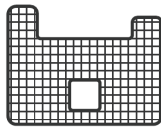

Velcro  
tape\*1



thick double  
sided tape\*1



Stand Velcro  
tape\*1

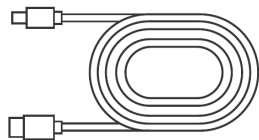

charging cable\*1

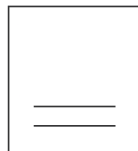

User manual\*1

### Note

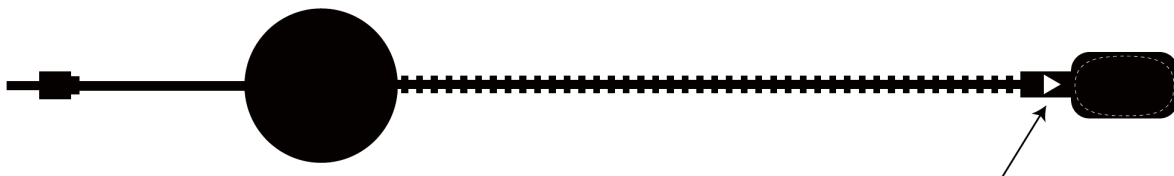



After installation the hard microphone,

please ensure that the <  > symbol is aligned with the direction of your mouth; otherwise, there may be noise during the call.