

# [Shenzhen Kenuo Digital Technology RV wireless Bluetooth speaker User Manual](#)

## [Manualsum](#), simplified manuals

### Table of Contents

- [Shenzhen Kenuo Digital Technology RV wireless Bluetooth speaker User Manual](#)
  - [DW-BT-MAGI RV Speaker User's Guide](#)
  - [Each part button](#)
  - [Key operation instructions](#)
  - [Bluetooth pairing](#)
  - [TWS Function](#)
  - [Speaker charging](#)
  - [Wireless charging](#)
  - [Power saving mode](#)
  - [Magnetic fixation](#)
  - [Product parameters](#)

# **Shenzhen Kenuo Digital Technology RV wireless Bluetooth speaker User Manual**

Shenzhen Kenuo Digital Technology RV wireless Bluetooth speaker User Manual

FCC id: [2AW3E-K121](#)

# DW-BT-MAGI RV Speaker User's Guide

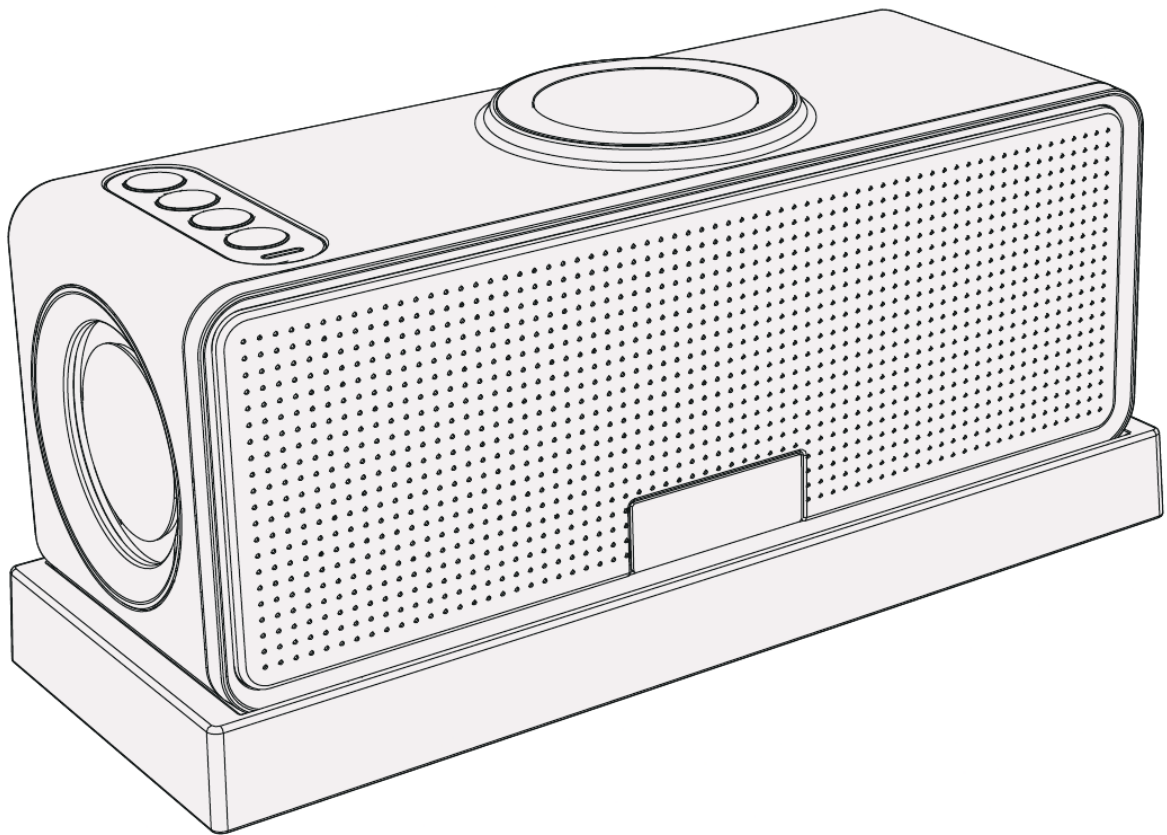

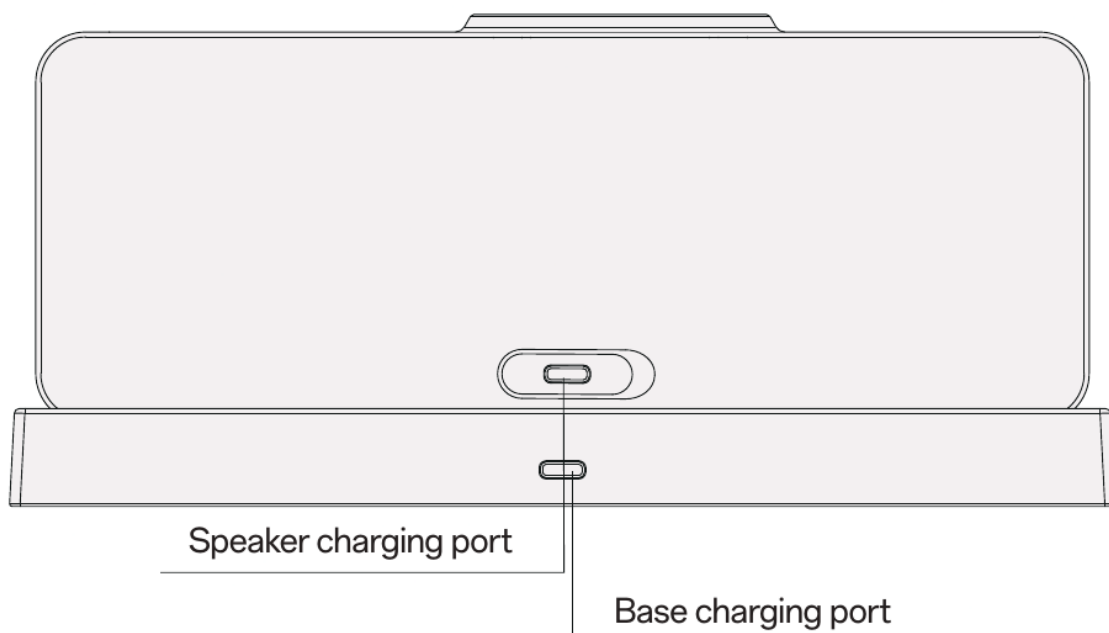
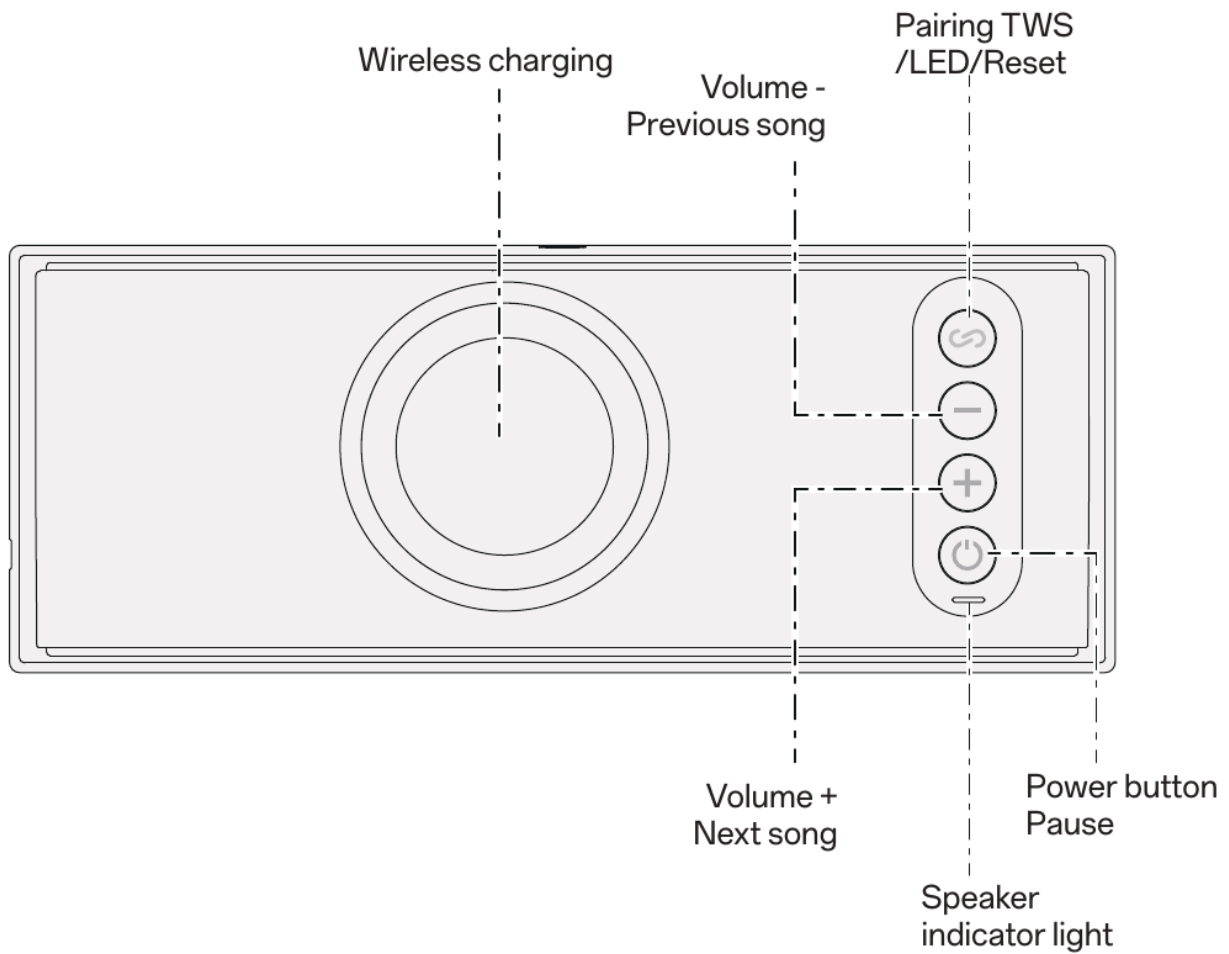

# Each part button

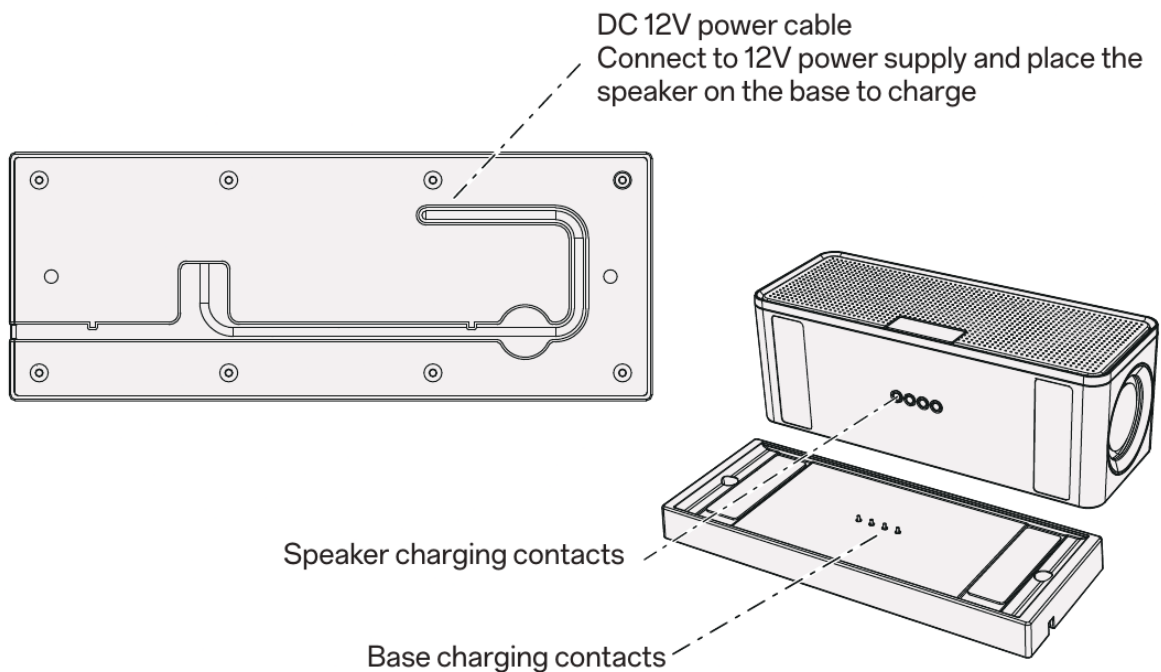



## Key operation instructions

Button	Name	Function Description
	Power button	<ul style="list-style-type: none"> <li>• Power on: Press and hold for 2S to power on. It will enter Bluetooth pairing mode by default.</li> <li>• Power off: Press and hold for 2S to power off</li> <li>• Pause/Play: Click to play/pause</li> </ul>
	Pairing TWS	<ul style="list-style-type: none"> <li>• Connection: Double-click to enter TWS pairing mode. When pairing is in progress, the RGB light flashes blue. The connection is successful. The blue light stays on. If there is no pairing within 60S, the TWS mode will be automatically exited.</li> <li>• Disconnect: Double-click to exit TWS mode</li> </ul>
	LED Mode	<ul style="list-style-type: none"> <li>• Lighting effect: Click to cycle through RGB (Colorful Transformation-Colorful Breathing-Colorful Rotation-Purple-Light Blue-Yellow-Turn off the light). The last lighting effect is defaulted when turned on.</li> </ul>
	Reset	<ul style="list-style-type: none"> <li>• Reset: Press and hold for 5S to restore factory settings</li> </ul>



Volume -  
Next song

- Volume reduction: Click to reduce the volume, click continuously to quickly reduce the volume.

- Next song: Press and hold for 2S to next song



Volume +  
Previous song

- Volume increase: short press to increase volume, long press to quickly increase volume.

- Previous song: Long press 2S to go to the previous song



Speaker indicator light

- Wireless charging: the green light is always on, foreign object detection: the red light is always on;
- Speaker charging: The blue light always on during charging, and turns off when the battery is fully charged.



Speaker charging port

- The speaker is charging. When charging, the blue light is always on, and when fully charged, the light goes off.



Base charging port

- The base is connected to the power supply.
- Speaker charging: When charging, the blue light is always on, and when fully charged, the light goes off.

## Bluetooth pairing

1. Bluetooth connection: Open the Bluetooth speaker and enter the Bluetooth pairing interface of the mobile phone. Search for the Bluetooth name: DW-BT-MAGI and click to connect.
2. Tip: If you cannot find the Bluetooth name, please press and hold the c-> key for 5 seconds. After the Speaker is reset, search for Bluetooth again to connect.

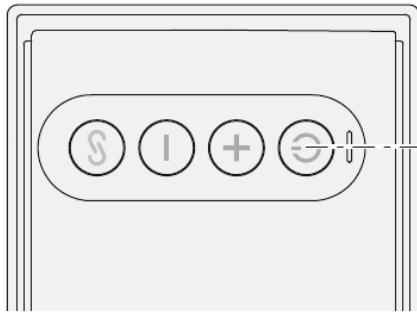

Power on: Press and hold for 2S to power on. It will enter Bluetooth pairing mode by default.

## TWS Function

Two speakers are close to each other. After turning on the phone, without connecting to Bluetooth, double click the “pairing button” of one of the speakers for 2 seconds and wait for about 10 seconds. The two speakers will automatically pair. Open the Bluetooth interface of the mobile phone and search for “DW- BT-MAG?1”, click Connect, the connection is successful, and the two speakers can play songs at the same time;

## Speaker charging

1. Connect the DC5V power supply to the Type-C charging port of the Speaker for charging.
2. Place the speaker on the charging base, connect the DC5V power supply to the Type-C charging port of the base or connect the base power cord to the 12V power supply for charging; Tip: During charging, the blue light on the Speaker is always on, and when fully charged, the light turn off.

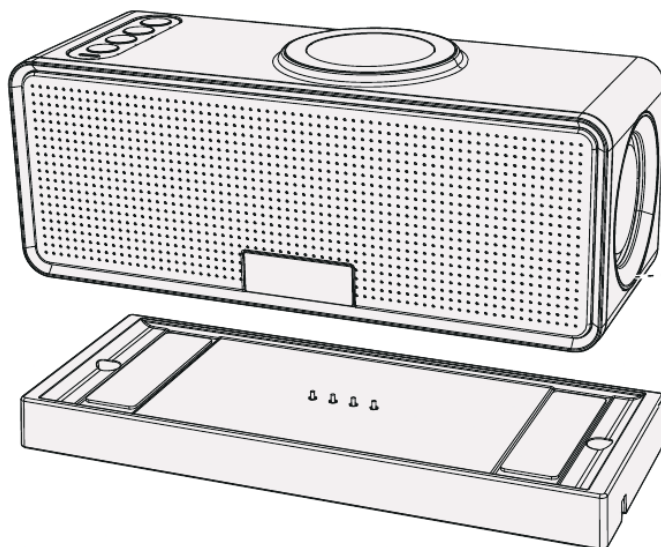

The speaker is placed on the charging base to charge

## Wireless charging

1. Wireless output: 5WW Max.

2. For mobile phones that support wireless charging, place them in the wireless charging sensing area to charge the phone.
3. Tip: When the power supply is not connected, playing songs while charging mobile phone will consume power very quickly. The battery can only last for about an hour. It is recommended to connect the power supply before charging the phone. When the speaker runs out of power, it will not be able to charge the mobile phone. The speaker needs to be fully charged or connected to a power supply before the wireless charging output can be used to charge the mobile phone;

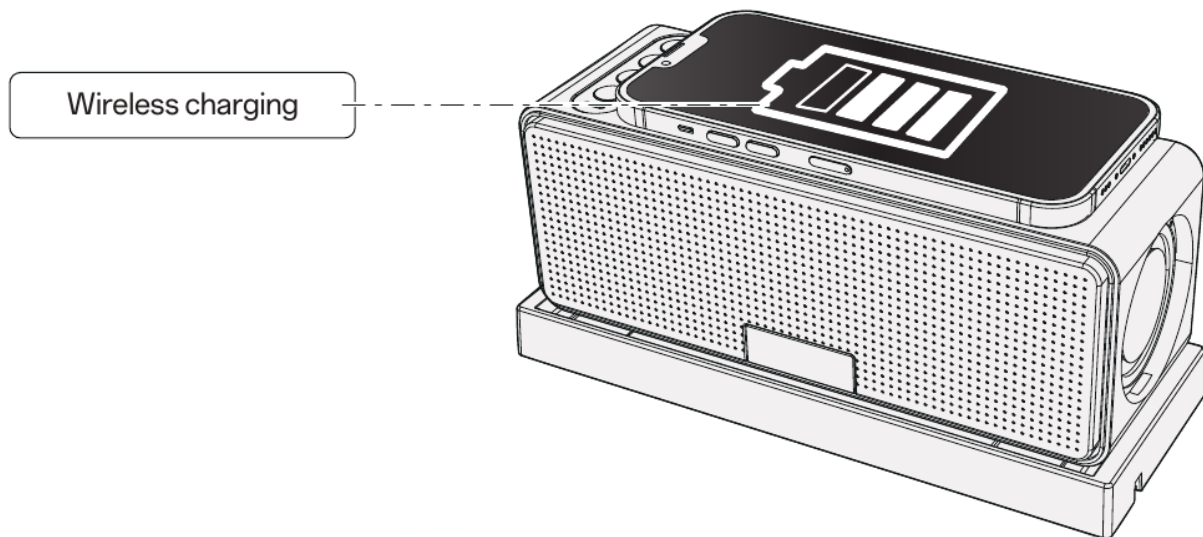

## Power saving mode

Charging: The blue light is always on during charging, and turns off when the battery is fully charged.

The charging port of the base is connected to the Type-C charger. The base is connected to the power supply, and the Speaker is charged. During charging, the blue light is always on, and the light goes off when the battery is fully charged.

## Magnetic fixation

There are built-in magnets on both sides of the bottom, which can be attached to golf carts or other iron materials to play music.

**Tips:** Please do not attach to dangerous objects, such as electrical boxes, to avoid causing personal injury or damaging the speaker;

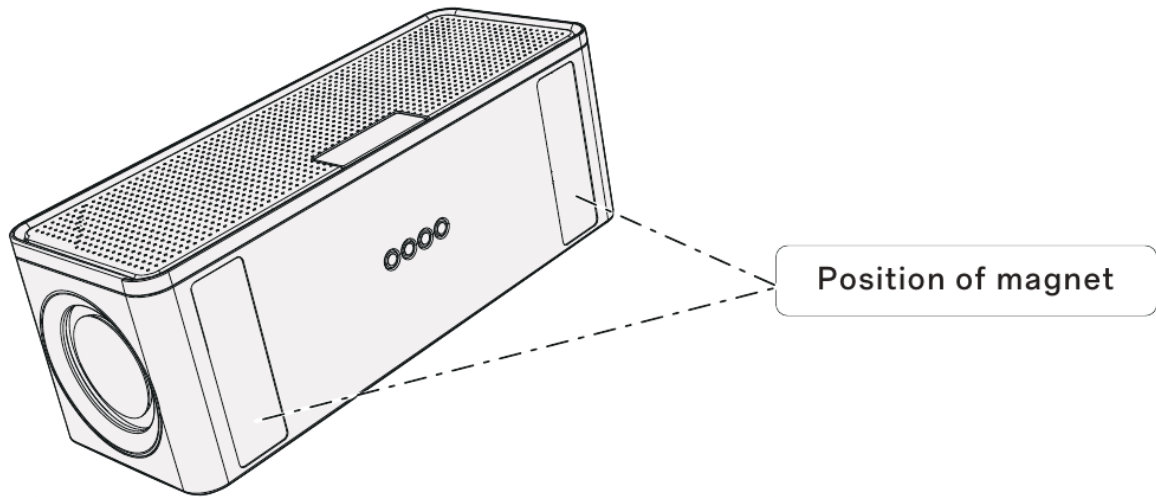

## Product parameters

<b>Model</b>	DW-BT-MAGI	<b>Bluetooth version</b>	5.3
<b>Speaker power</b>	20*10W (RMS)	<b>Charging time</b>	25H
<b>Play time</b>	12H (50% volume)	<b>Product size</b>	210*75*79mm
<b>Battery Capacity</b>	2200mAh/7.4V	<b>Wireless charging output</b>	5W Max
<b>Waterproof level</b>	IPX6	<b>Charging voltage</b>	DC 5V/DC 12V (charging base)
<b>Support Functions</b>	A2DP V1.3, AVRCP V1.6, TWS Bluetooth music, TWS interconnection, 5W wireless charging, magnetic fixation		

1. Please read the manual carefully and use the product according to the operating instructions.
2. Please use or store this product at room temperature.
3. Do not use this product near heat sources, such as radiators, heaters or other heating devices.
4. In order to protect your hearing and extend the life of the product, please do not adjust the volume to the maximum for a long time.
5. Please choose a charger that is certified by a regular manufacturer to charge the product.
6. It is recommended to fully charge the product before using it for the first time. If the product has not been used for a long time, please fully charge the product every 3 months to avoid battery damage.