

Shenzen LED Projector User Manual 2AZFE-ON03PRO

Manualsum, simplified manuals

Table of Contents





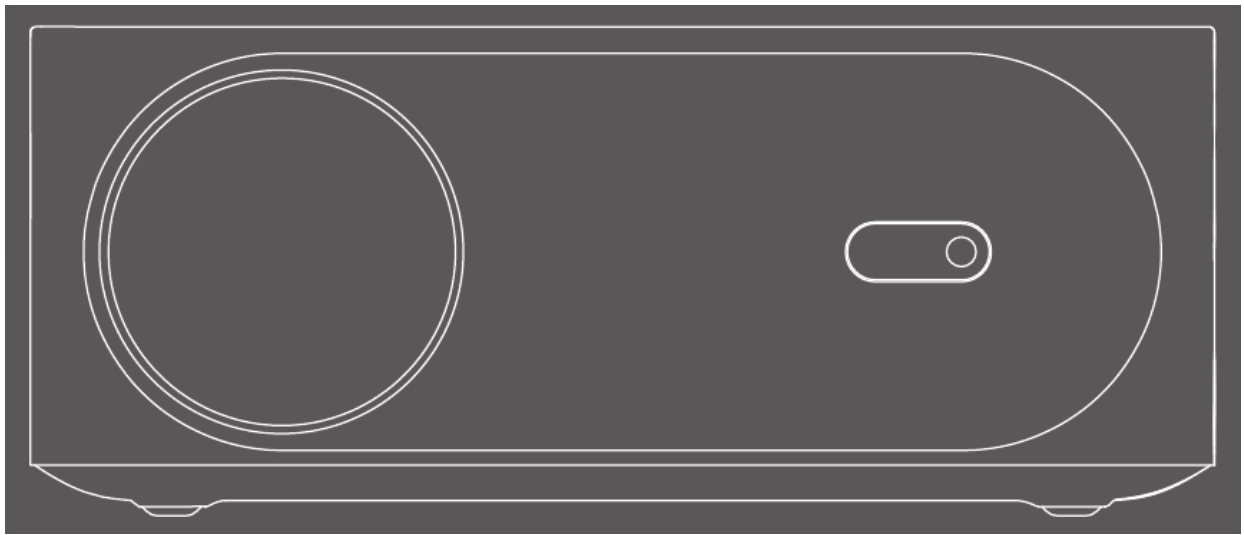





- [Shenzen LED PROJECTOR User Guide](#)
 - [01. Remote control introduction](#)
 - [02. Host Appearance and Function Description](#)
 - [03. Interface Connect](#)
 - [04. Setting](#)
 - [05. APP](#)
 - [First Step](#)
 - [Second step](#)
 - [06. Miracast and DLNA/MagicCast](#)
 - [07. Speaker Mode Setting](#)
 - [First Step](#)
 - [Second step](#)
 - [Third step](#)
 - [08. E-manual](#)
 - [First Step](#)
 - [Second step](#)
 - [09. Electronic Focusing](#)
 - [Electronic focusing](#)
 - [10. Projection Distance & Size](#)
 - [11. Technology Features](#)
 - [12. Unload The Dust Net and Clear](#)
 - [First Step](#)
 - [Second step](#)
 - [Third Step](#)
 - [13. Projector Installation](#)
 - [Desktop use](#)
 - [Hoisting and use](#)

Shenzen LED PROJECTOR User Guide

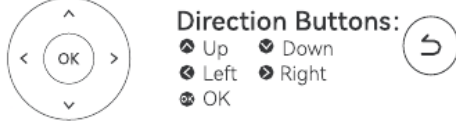

01. Remote control introduction



-  **Power button:**
Turn on/off
-  **Mute button:**
Mute
-  **Focus button:**
Adjust focal distance
-  **Input button:**
Choose to enter the Application Center, HDMI
-  **Back button:**
return to last step
-  **Quick Menu Key:**
Enter the setting pop-up window interface
-  **Home button:**
short press and return to the homepage
-  **Direction Buttons:**
▲ Up ▼ Down
◀ Left ▶ Right
● OK
-  **Volume button:**
Volume-, Volume+
-  **NETFLIX:**
Direct enter NETFLIX
-  **YouTube:**
Direct enter YouTube
-  **Prime video:**
Direct enter PrimeVideo

To avoid power shortage, please do not mix up the old and new batteries. To avoid battery leakage and corrosion, please take the battery out if do not use remote control for a long time.

02. Host Appearance and Function Description

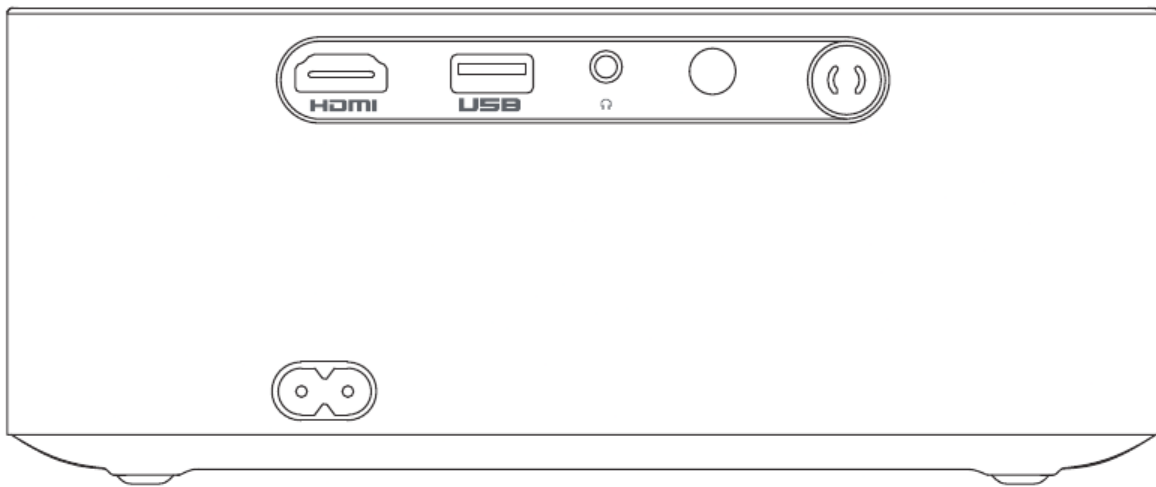

03. Interface Connect

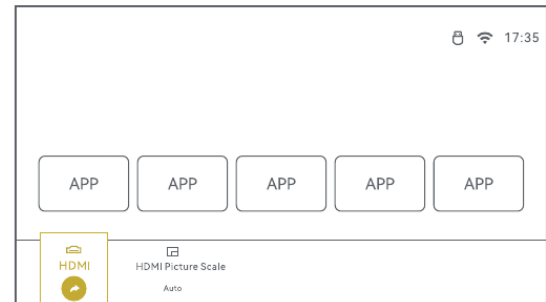
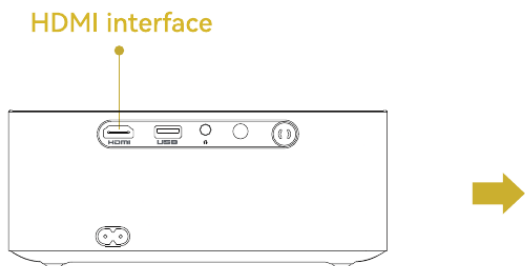
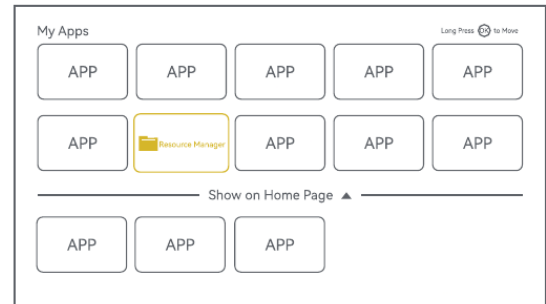
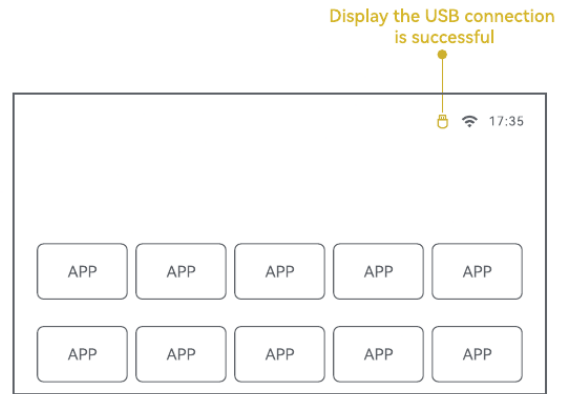
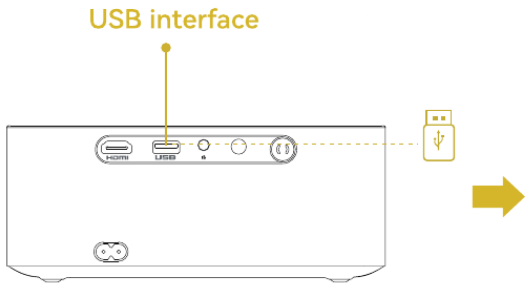

04. Setting

• WIFI Setting

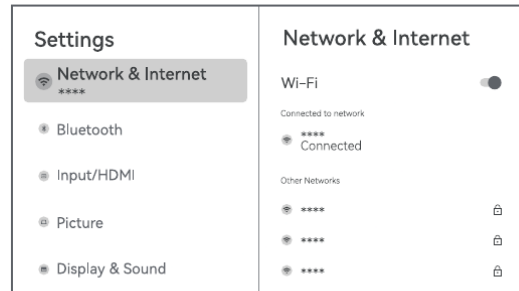

• On the homepage, select Settings

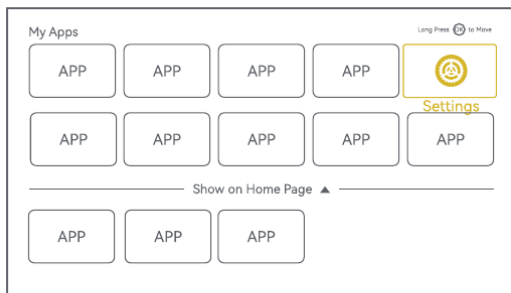

• Bluetooth Setting

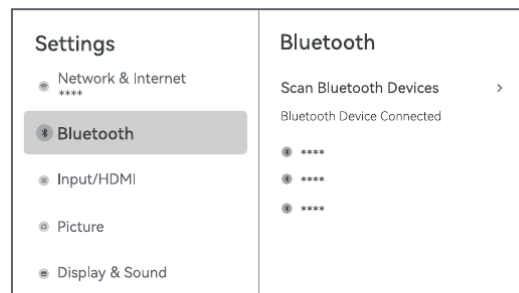

• Input/HDMI Setting

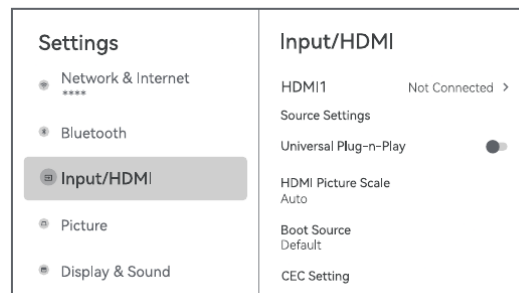

05. APP

First Step

- On the homepage, select My APPS–Netrange

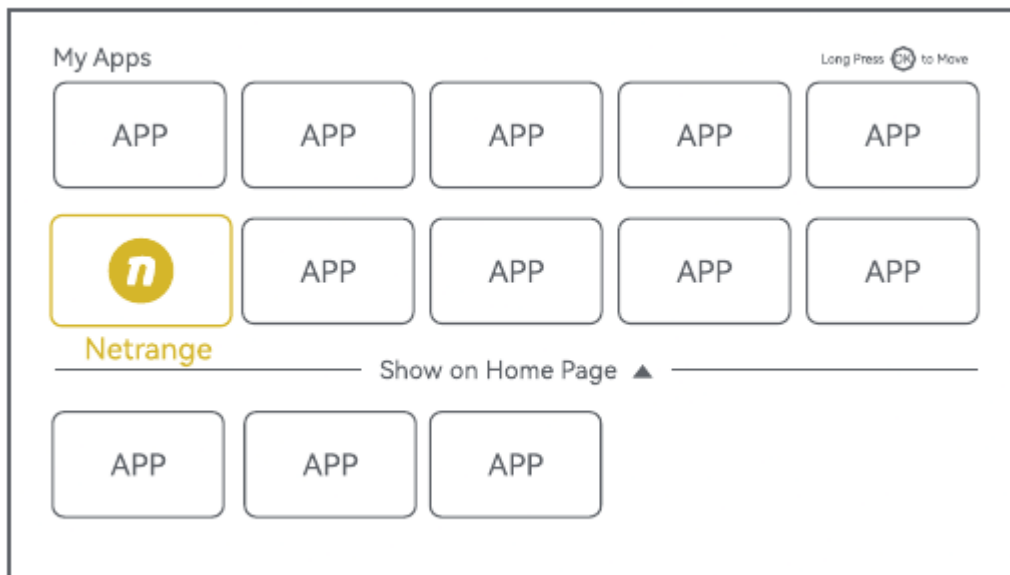

Second step

- You can search for what you need

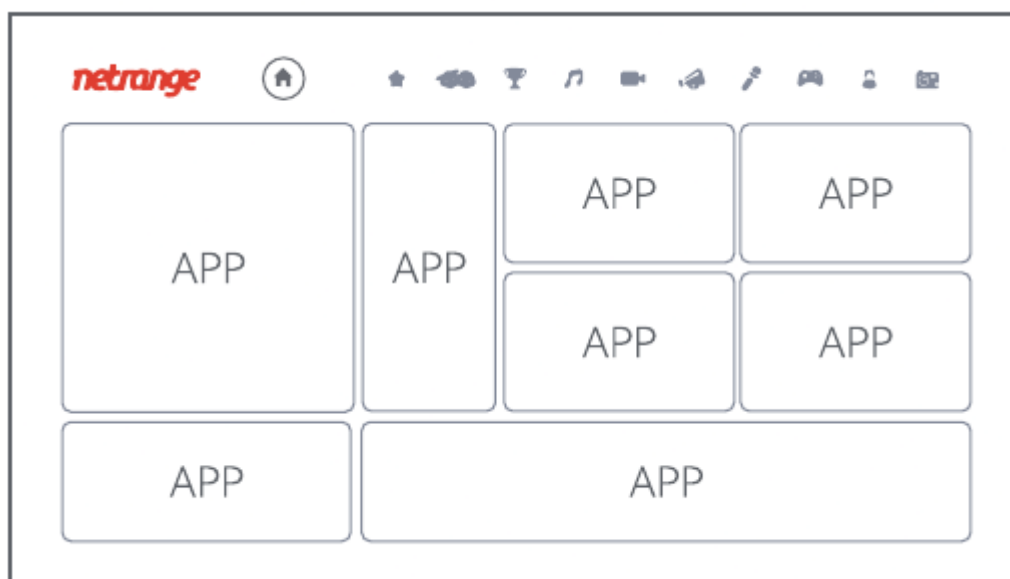

06. Miracast and DLNA/MagicCast

- On the homepage, ScreenCast Assistant

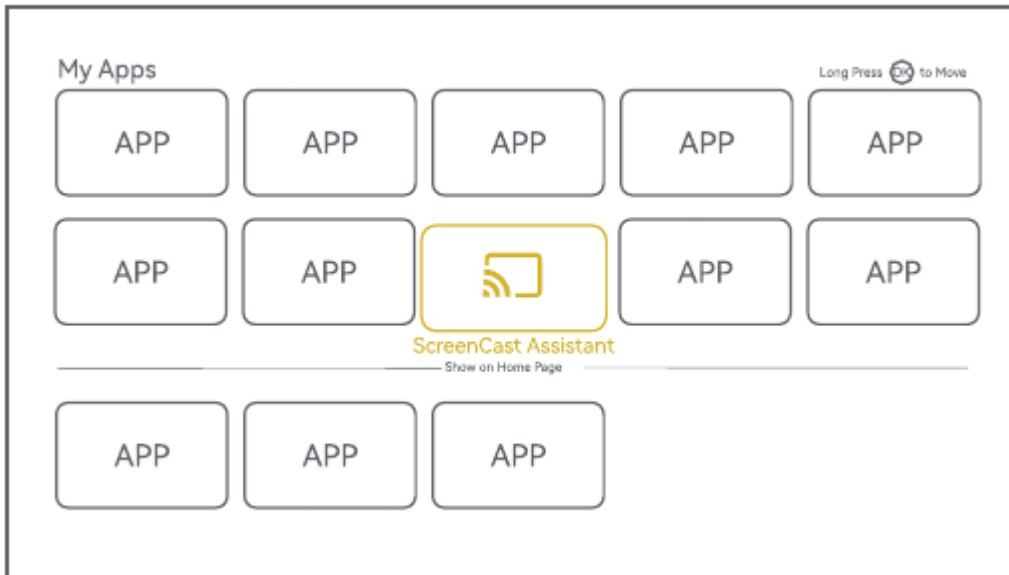

- Miracast

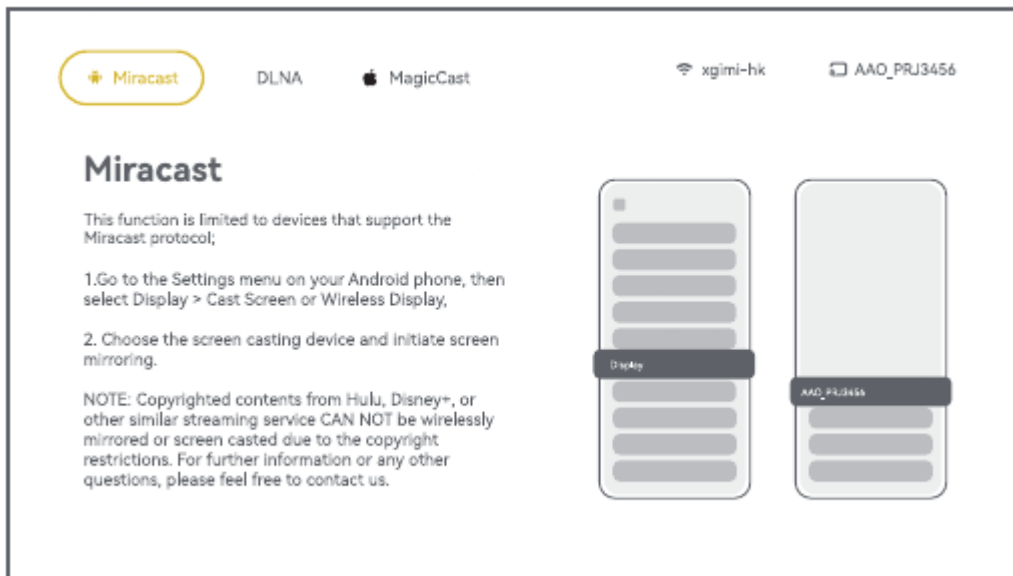

- DLNA

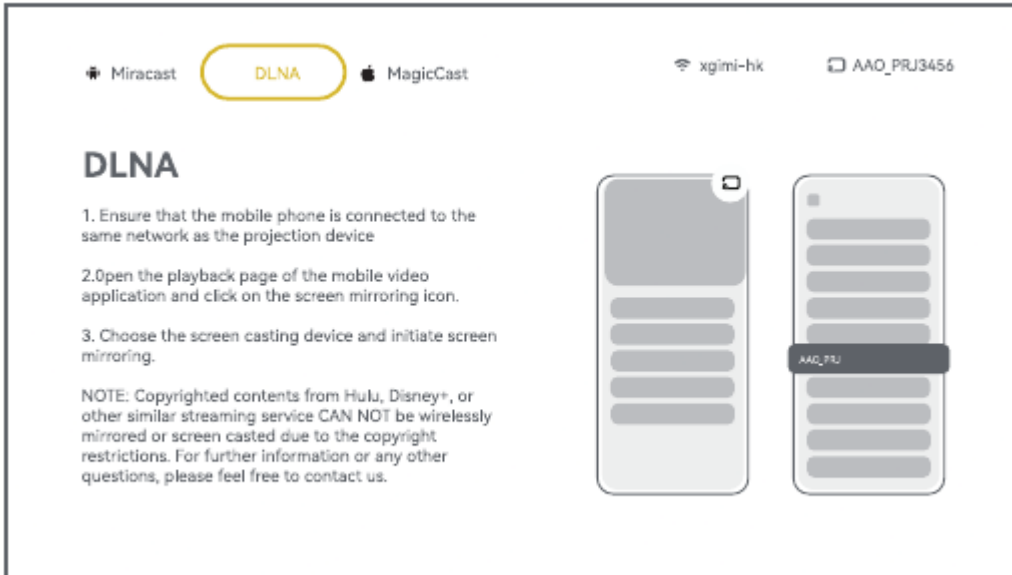

- MagicCast

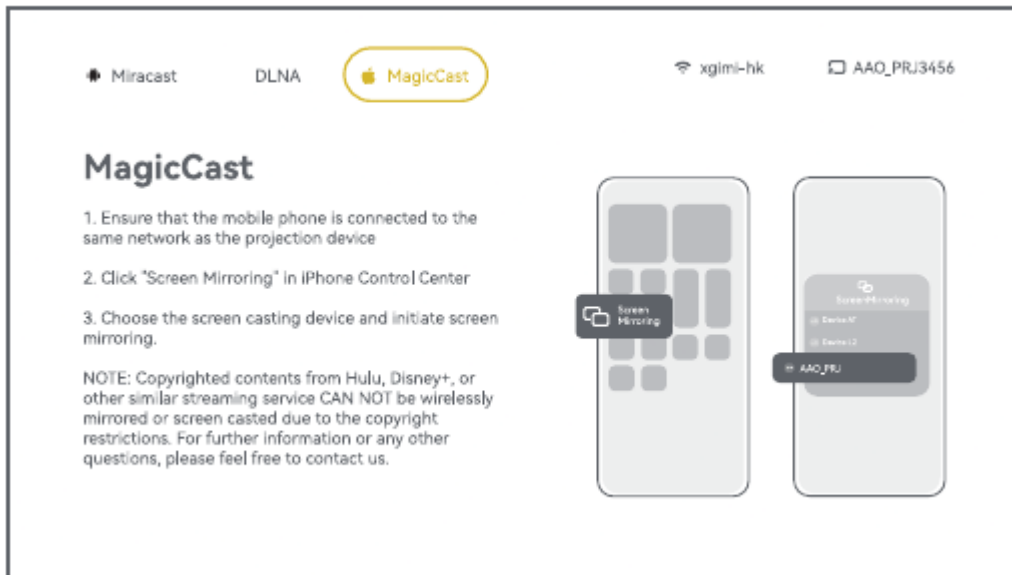

07. Speaker Mode Setting

First Step

- On the homepage, select My APPS–Bluetooth Speaker

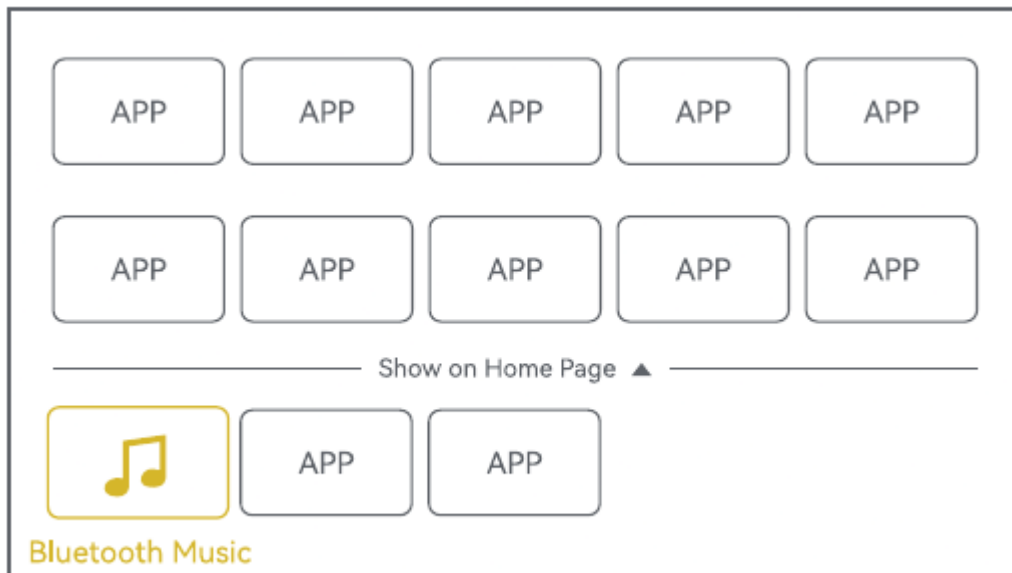

Second step

- Connect to the Bluetooth for playing music

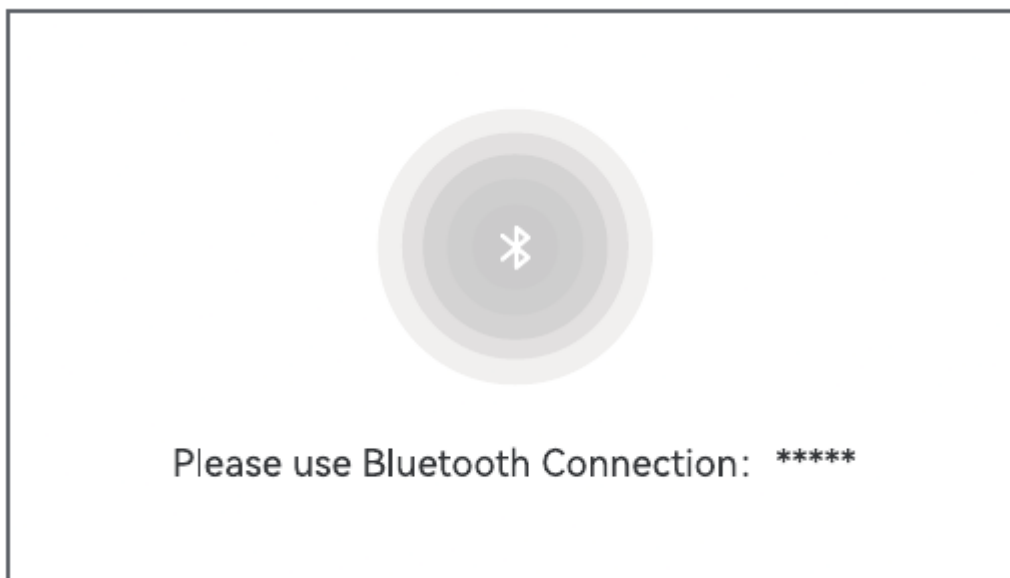

Third step

- Playing music

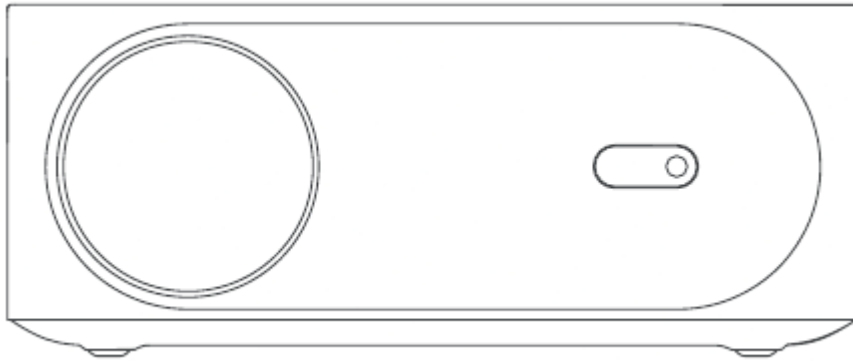

08. E-manual

First Step

- On the homepage, select My APPS-E-manual

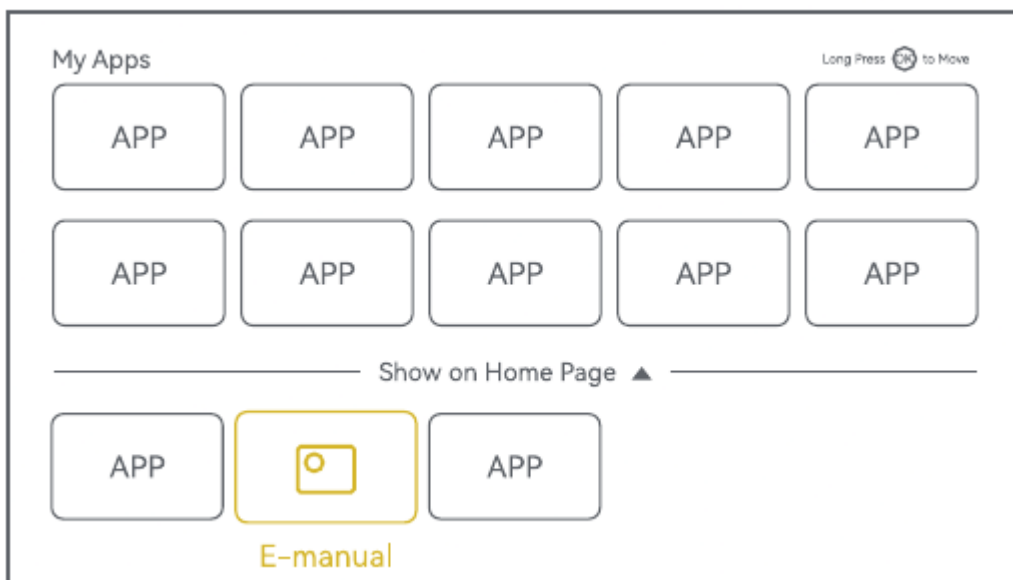

Second step

- For more information, please refer to the E-manual field inquiry.

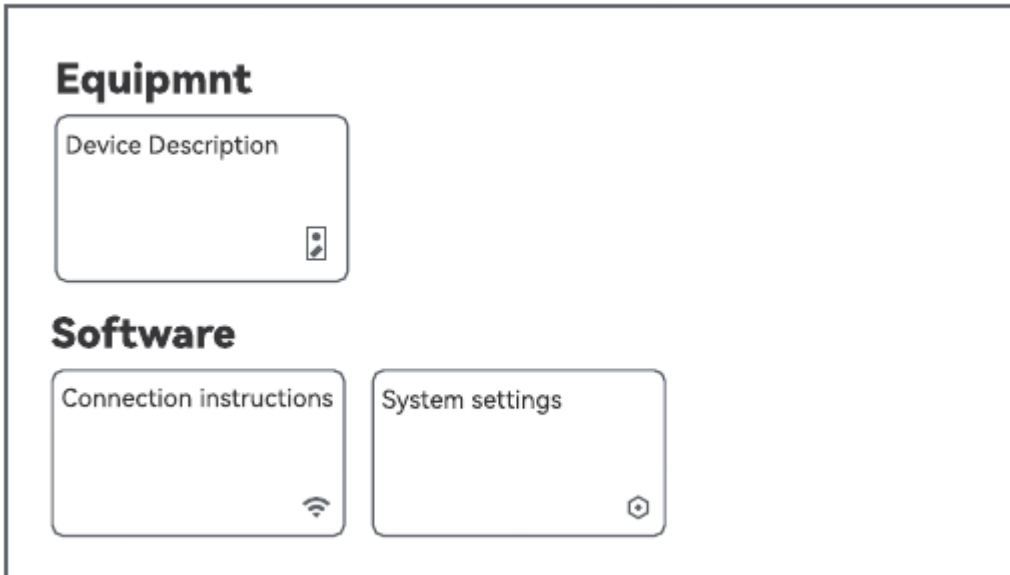

09. Electronic Focusing

Electronic focusing

Press the “-” and “+” buttons on remote control to adjust the clarity

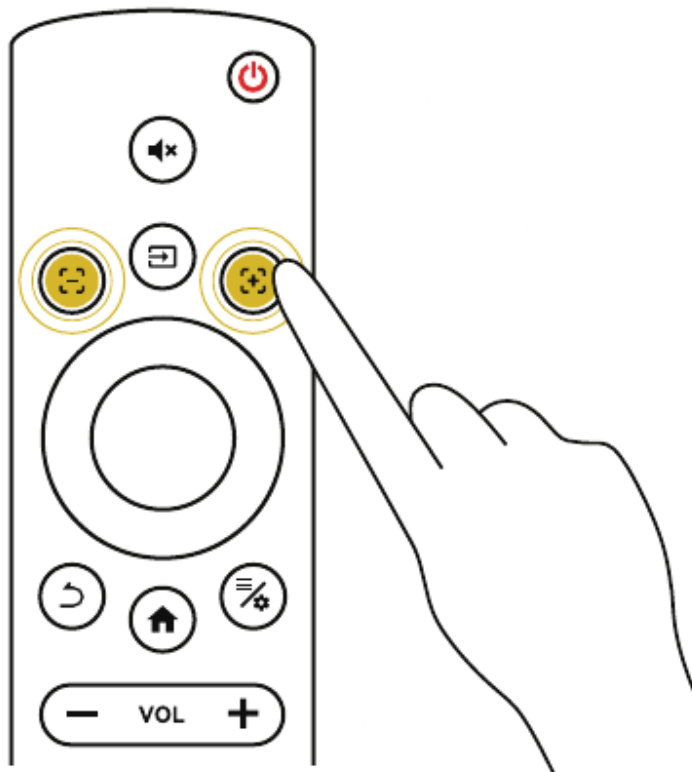

10. Projection Distance & Size

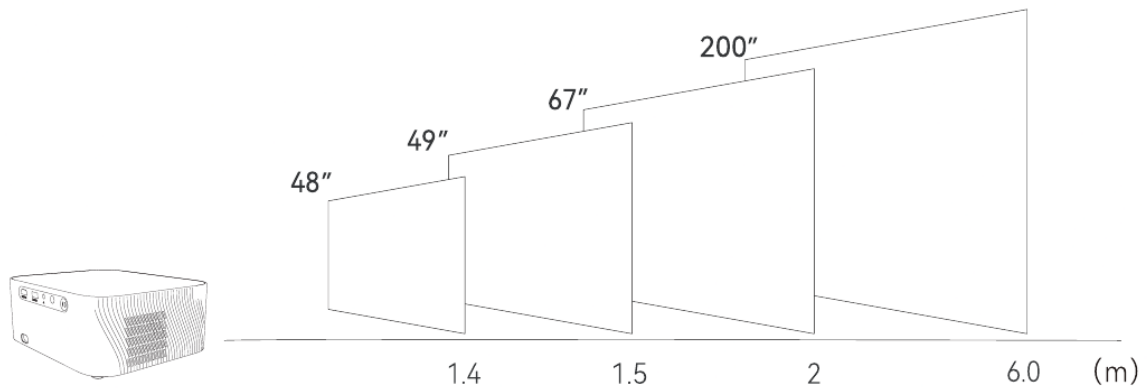

11. Technology Features

Imaging Technology	TFT LCD
Native Resolution	1920*1080
Light Source	LED
Focus Mode	Manual Focusing
Projection Distance	1.4 - 6.0 (m)
Screen Size	48-200 Inches
Aspect Ratio	16:9 and 4:3 and Auto Fit
Power Input	100V-240V-50/60HZ
Input	USB*1/HDMI*1
Output	Earphone
Speaker	4Ω 3W
Unit Size	200*167*80mm
Net Weight	1.11KG
Throw Ratio	1.35:1

12. Unload The Dust Net and Clear

First Step

- Take out dust net from the projector bottom

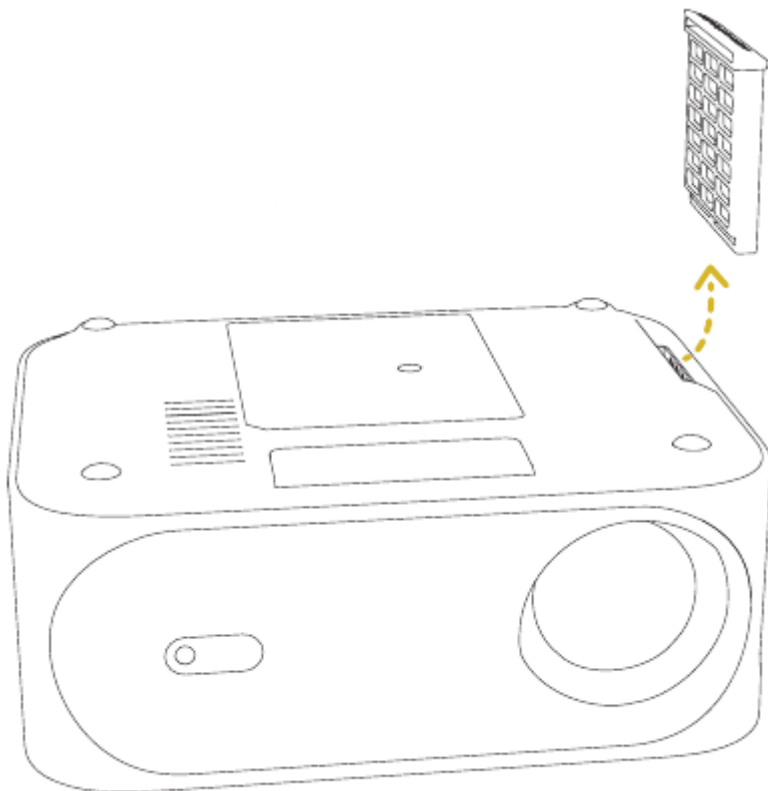

Second step

- Clean the dust net
- For your safety, please cut off the power before cleaning



Third Step

- Align the bottom bayonet and install the dust net

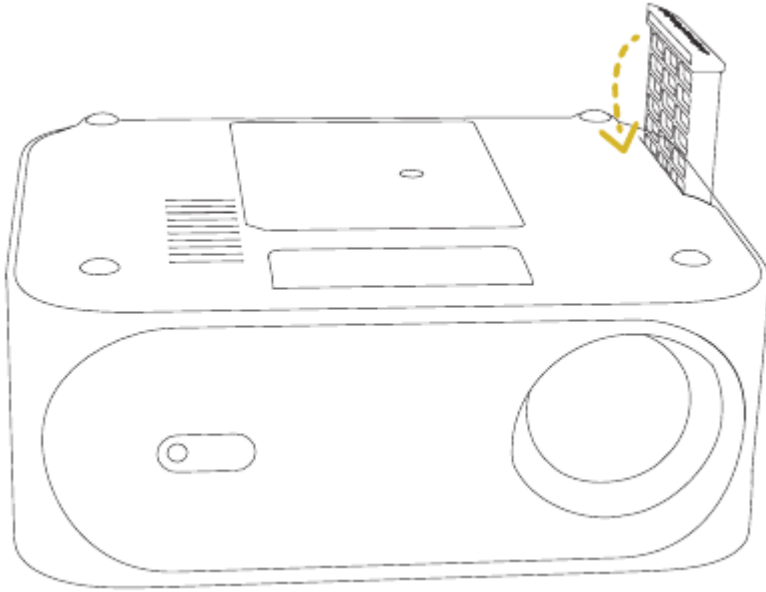

13. Projector Installation

Desktop use

① attachment bracket

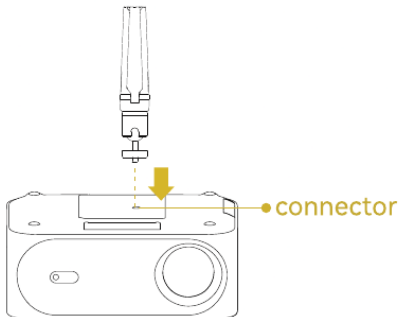

② Rotate the bracket until it is fixed.

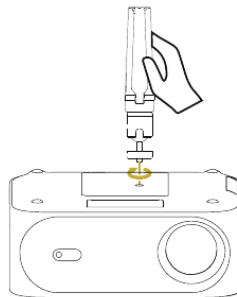

③ Installation completed

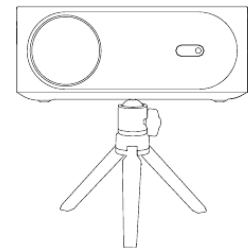

Hoisting and use

① attachment bracket

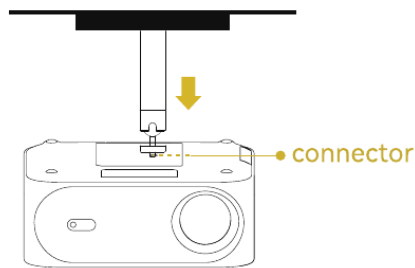

② Rotate the machine to a fixed position.

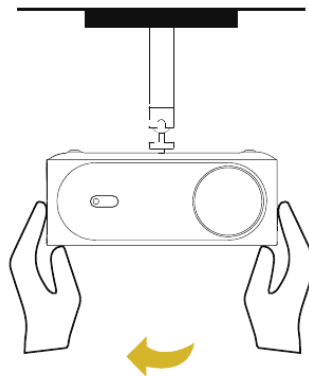

③ Installation completed

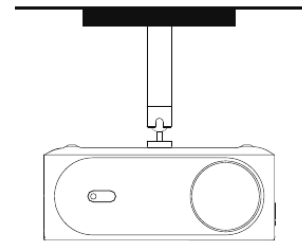

Please read the notes carefully:

1. To ensure stable power supply, please use national standard power cable and power cord with grounding;
2. Please use the type of power supply indicated on the projector and the supplied power supply for power supply;
3. Please do not disassemble the machine yourself, otherwise the company will not undertake warranty service;
4. Do not look directly at the projector lens while the machine is working, it might cause damage to your eyes;
5. To prevent clogging the projector vents, do not cover them with cloth, carpet or other materials;
6. This projector does not have waterproof function, please keep it away from rain, moisture and other items containing liquid such as vase, cup, etc;
7. To prevent electric shock, please keep the projector away from rain, water or moisture;
8. Cut off the power supply if do not use this projector for a long time;
9. Use the original foam or other anti-shock material to protect projector if you need transport this projector;
10. If you find the projector has problems, please contact with the supplier, do not repair by yourself;
11. To extend the projector life span and protect your eyesight, we suggest you may have a break after 3-4 hours using.