

Shenzhen Yiyue Helmet Bluetooth Intercom User Manual 2BGL7TK4

Manualsum, simplified manuals

Table of Contents

- [Helmet Bluetooth Intercom User Manual 2BGL7TK4](#)
 - [Product Specifications](#)
 - [Packing List](#)
 - [Product Presentation](#)
 - [Product Installation](#)
 - [Product Operation](#)
 - [5.1 Rotary Wheel Instructions](#)
 - [5.2 Power On/Off Instructions](#)
 - [Power On:](#)
 - [Power Off:](#)
 - [Low Battery Warning](#)
 - [Charging Indicator](#)
 - [5.3 Mobile Connection](#)
 - [Method I:](#)
 - [Method II:](#)
 - [Mobile Reconnection Function](#)
 - [5.4 Mobile Control](#)
 - [Answering a phone call](#)
 - [Ending a call](#)
 - [Rejecting a phone call](#)
 - [Canceling automatic answer](#)
 - [Priority Phone Call](#)
 - [Voice Assistant](#)
 - [Music Control](#)
 - [5.5 Radio \(FM\)](#)
 - [Enable/Disable FM 76MHz~108MHz](#)
 - [Enable FM:](#)
 - [Disable FM:](#)
 - [FM Channel Switch](#)
 - [Mode Introduction](#)
 - [6.1 Bluetooth Intercom Mode](#)
 - [Intercom Between Two TK-X4 Devices](#)
 - [Intercom Disconnection](#)

- [Intercom Reconnection](#)
- [6.2 Bluetooth Group Intercom Mode](#)
 - [One-Click Network Connection for 4 People](#)
 - [Intercom Disconnection](#)
 - [Intercom Reconnection](#)
 - [Voice Number Announcement](#)
 - [3-Person Group Intercom](#)
 - [6-Person Group Intercom](#)
- [6.3 Music Sharing Mode](#)
 - [End Sharing](#)
 - [Reconnection for Sharing](#)
- [6.4 Common Pairing Mode](#)
 - [Disconnection](#)
 - [Reconnection](#)

Helmet Bluetooth Intercom User Manual 2BGL7TK4

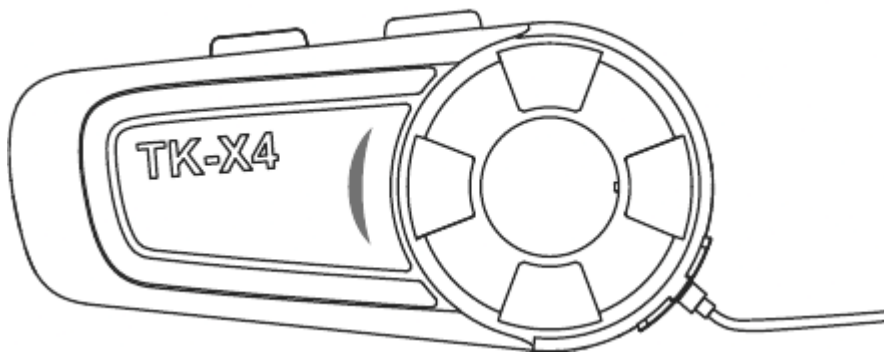

Product Specifications

Bluetooth version:	5.1
Standby time:	500 hours
Service time:	40 hours
Charging time:	Approximately 3 hours
Charging interface:	TYPE-C Interface
Power supply requirements:	5V=1A
Battery type:	Rechargeable lithium polymer battery
Operating temperature:	14°F ~122°F (-10°C~50°C)
Storage environment:	5°F~131°F (-15°C~55°C)

- The service time is related to the type of mobile phone and the usage status, and the actual time may be different.
- The service distance may change due to environmental and weather influences, etc.

Packing List

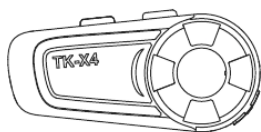

Máquina Principal

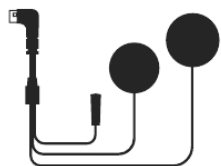

Cable de Auricular

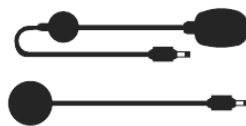

Micrófono de Palo
& Botón

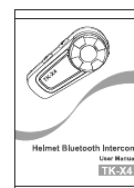

Manual de Usuario

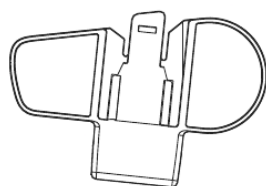

Clip



Clip de Velcro



Destornillador



Cable de Carga

Product Presentation

Rojo Azul Verde

Indicador Luminoso

Botón de Modo

Botón de Alimentación

Rueda Giratoria

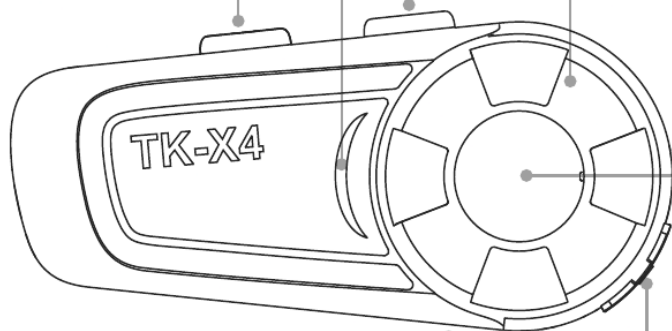

Botón de Teléfono

Interfaz de Auricular

Interfaz de Carga



Intercomunicación
Grupal de 6
Personas



Conexión de Red
por un Solo Clic



Eliminación de
Ruido DSP



Compartición de
Música



Impermeabilidad
IP67



Asistente de Voz



Radio FM



Estereofonía Hi-Fi

Product Installation

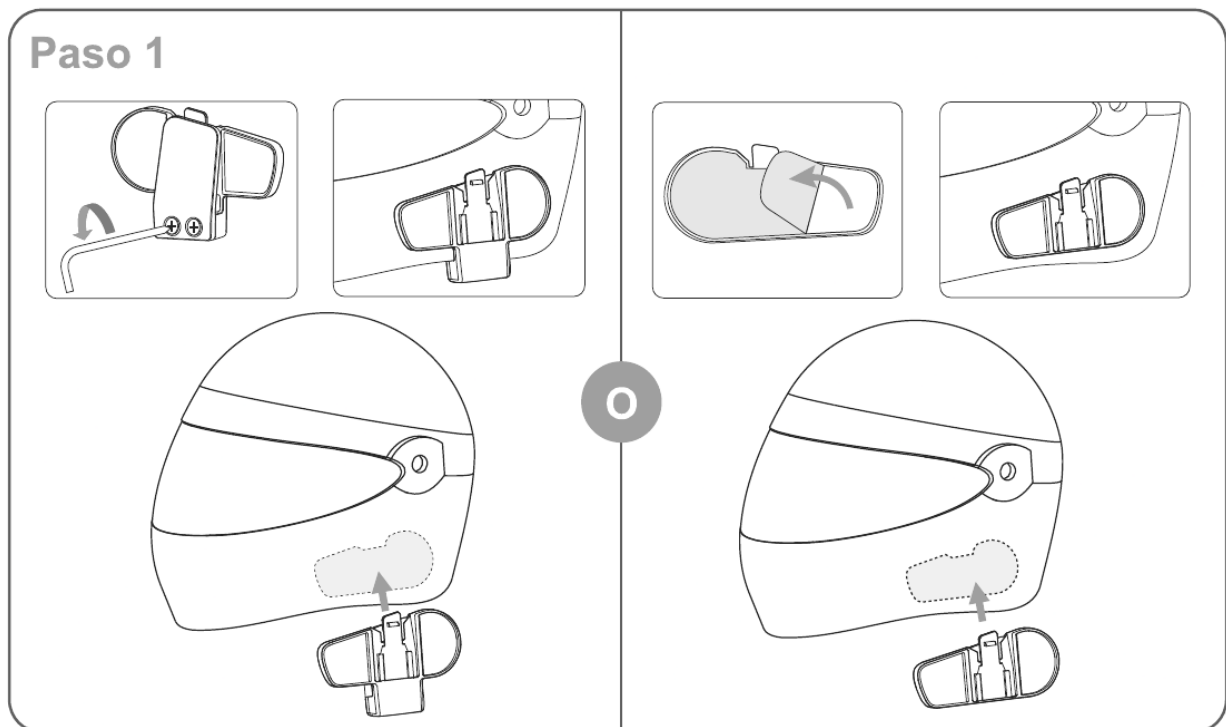

Paso 2

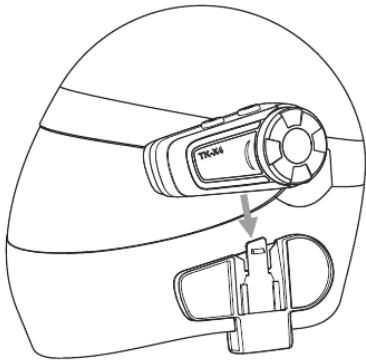

Paso 3

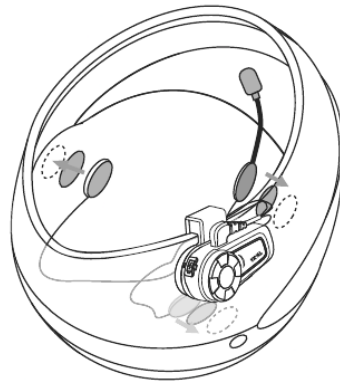

Paso 4

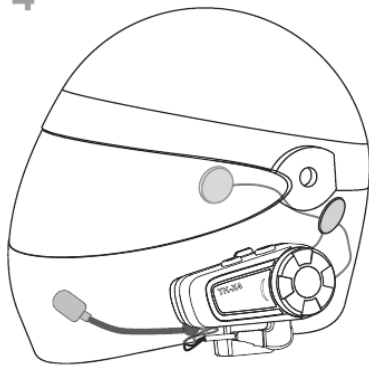

Paso 5



Product Operation

5.1 Rotary Wheel Instructions



Hacer un clic



Hacer doble clic

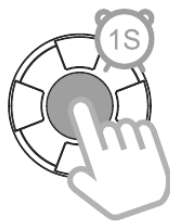

Mantener pulsada durante 1 segundo

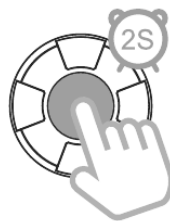

Mantener pulsada durante 2 segundos

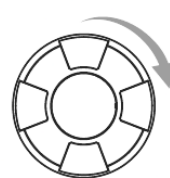

Girar en sentido horario

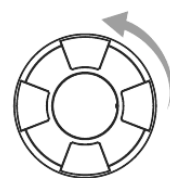

Girar en sentido antihorario

5.2 Power On/Off Instructions

Please fully charge before use.

Power On:

Hold down the power button for 2 seconds, until the red and blue lights flash alternately. The mode, current status, and current power (for instance: Power on, Welcome, Bluetooth Intercom Mode, Bluetooth Pairing, Battery High) will be announced automatically.

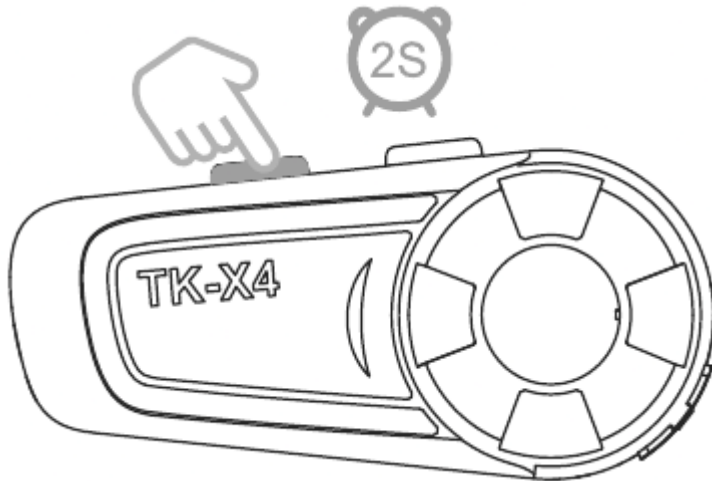
**Power Off:**

Hold down the power button for 4 seconds, until the indicator light goes off, accompanied by the warning sound 'Power Off'.

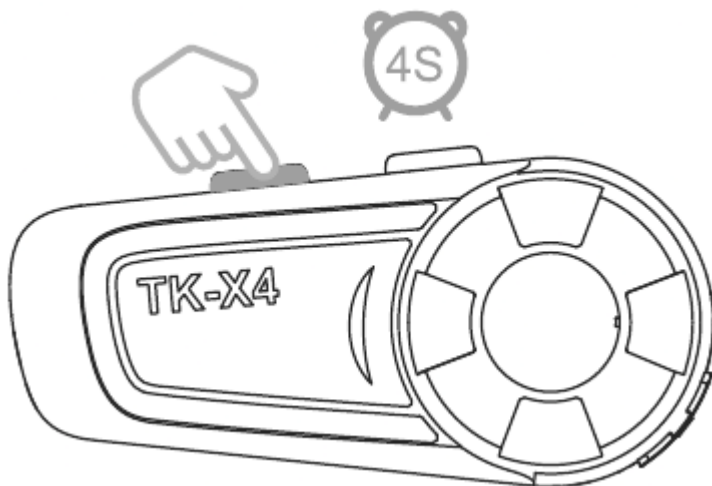

Low Battery Warning

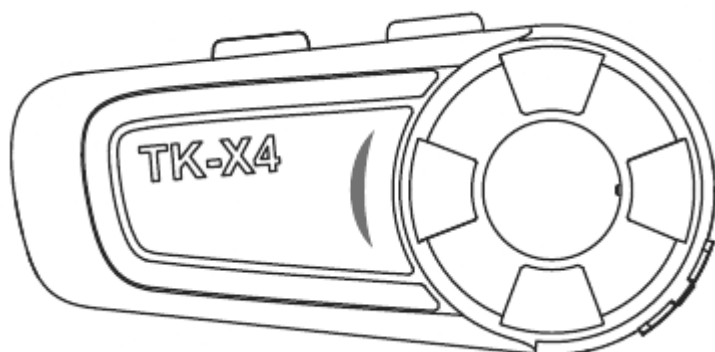

In case of low battery, the red light flashes once at 20-second intervals, accompanied by the warning sound 'Battery Low', and it turns off automatically if the battery is too low.

Charging Indicator

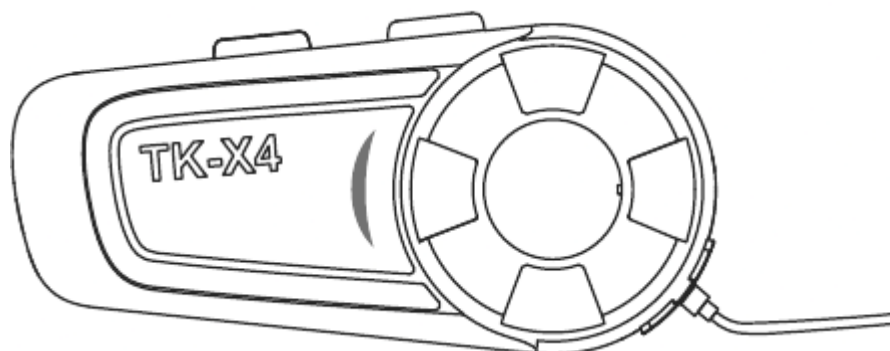

The red light stays on while charging, and turns off when fully charged.

5.3 Mobile Connection

After being turned on, it enters the state of alternating red and blue lights flashing, accompanied by the voice prompt 'Bluetooth Pairing'.

Note: There are two ways to enter the state of alternating red and blue lights flashing.

Method I:

A device whose Bluetooth pairing record has been deleted enters the state of alternating red and blue lights flashing once powered on.

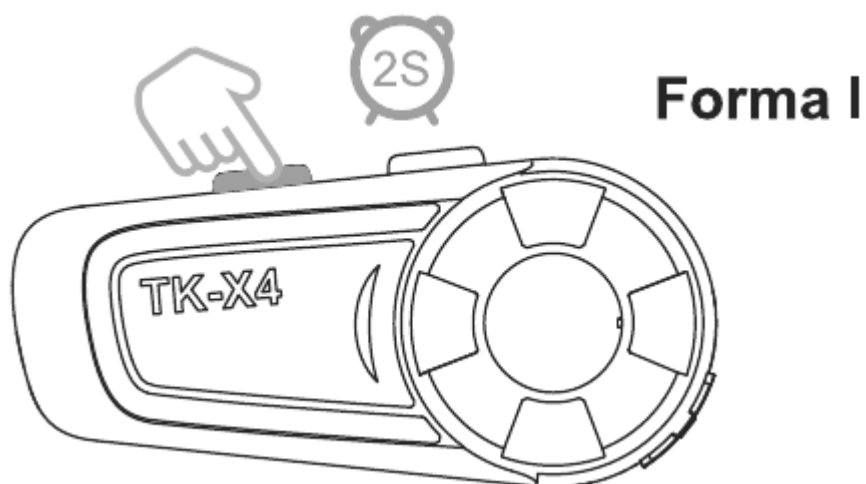

Method II:

In standby mode (Intercom Disconnected), by holding down the Power Button and the Phone Button at the same time for 2 seconds, it enters the state of alternating red and blue lights flashing.

Search for the device named TK-X4 with your mobile's Bluetooth, select and connect.

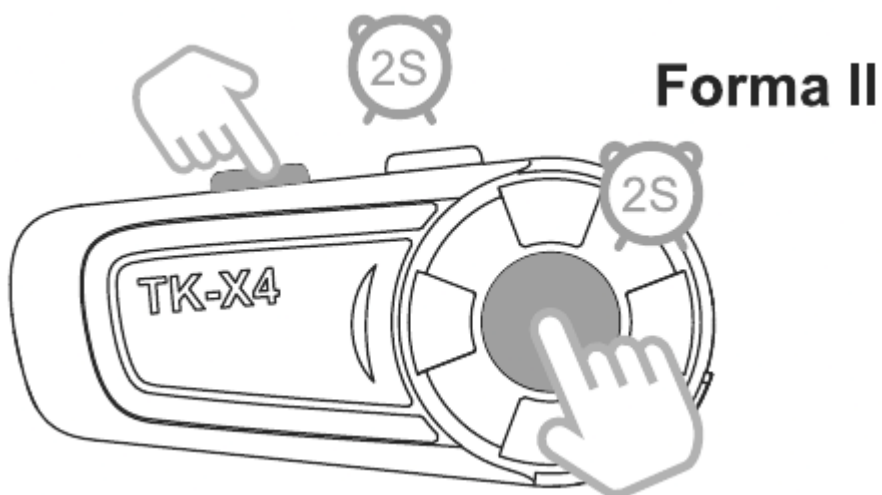

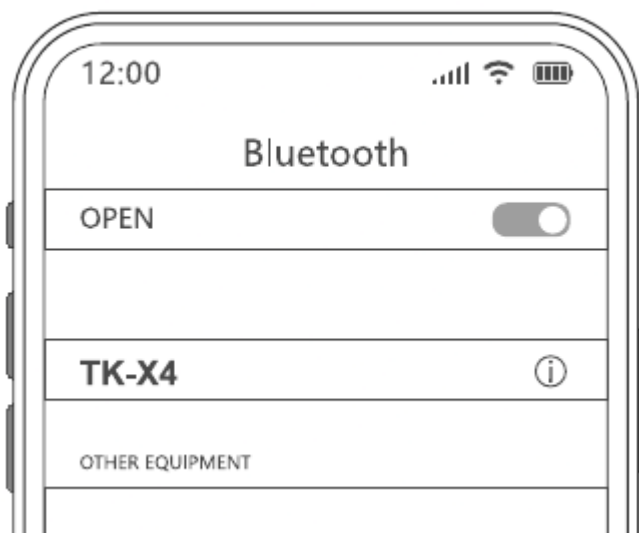

Mobile Reconnection Function

Once turned on, the TK-X4 Bluetooth headset can automatically reconnect with the last connected mobile and the blue light flashes slowly; if you need to connect to another mobile, please first delete the Bluetooth pairing record according to the following operations:

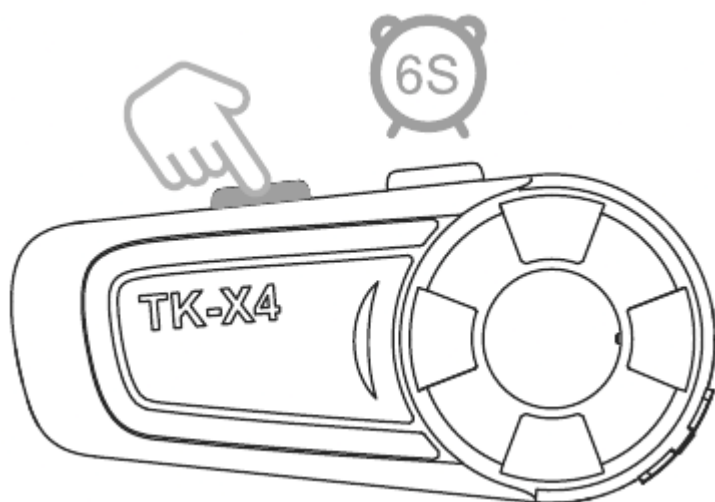

Deleting the Bluetooth pairing record: When powered off, hold down the Power Button for 6 seconds until you hear the warning sound 'Dudu' , and the red and blue lights flash twice at the same time.

5.4 Mobile Control

Answering a phone call

When there is an incoming call, it is answered automatically by clicking the Phone Button or after 12 seconds without operation.

Ending a call

Click the Phone Button during the phone conversation.

Rejecting a phone call

Hold down the Phone Button for 2 seconds when there is an incoming call.

Canceling automatic answer

While disconnected from mobile Bluetooth: Hold down the Phone Button for 2 seconds to cancel the automatic answer to calls, and please repeat the operations to restore it.

Priority Phone Call

When a call comes in, it automatically interrupts intercom, music, and FM radio, and automatically resumes after ending the call.

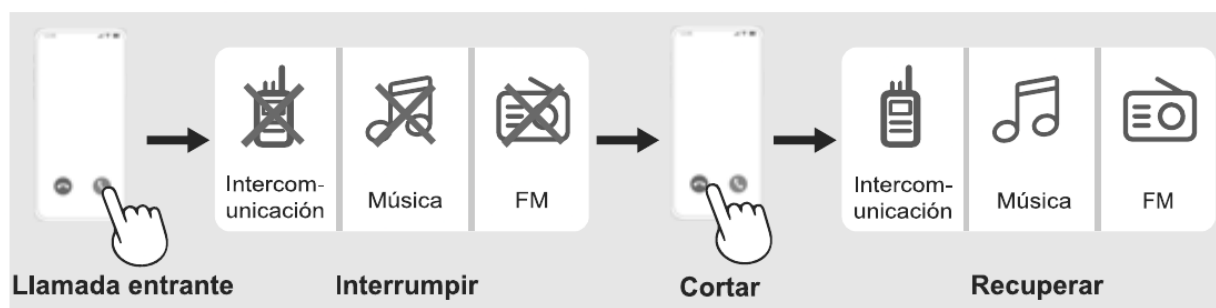

Voice Assistant

In standby mode, by holding down the Phone Button for 2 seconds, the voice assistant is enabled, accompanied by the warning sound 'Voice Dial' (requires mobile support).



Music Control

Reproducir

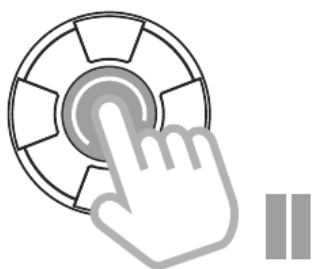

Canción próxima

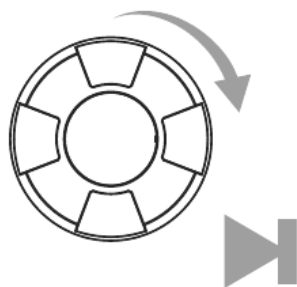

Canción precedente

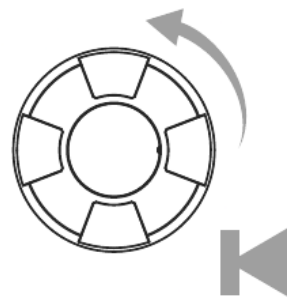

Pausar

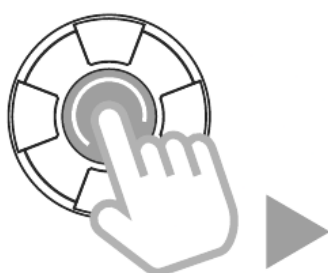

Volumen +

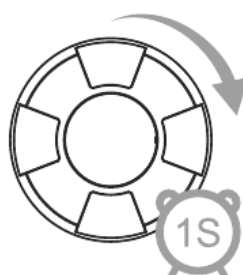

Volumen -

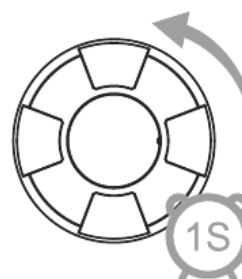

Volume Adjustment: Rotate and hold the rotary wheel. The volume adjusts one level every second. When it reaches the maximum volume, a warning sound 'Di' is emitted.

5.5 Radio (FM)

Enable/Disable FM 76MHz~108MHz

Enable FM:

In standby mode, double click the Phone Button, accompanied by the warning sound 'Turn On Radio'. Once FM is enabled, it automatically searches and broadcasts the radio.

Disable FM:

While listening to the radio, it can be disabled by double-clicking the Phone Button. Additionally, it automatically saves the radio station being listened to, so there's no need to search for it again the next time.

FM Channel Switch

FM ascendente

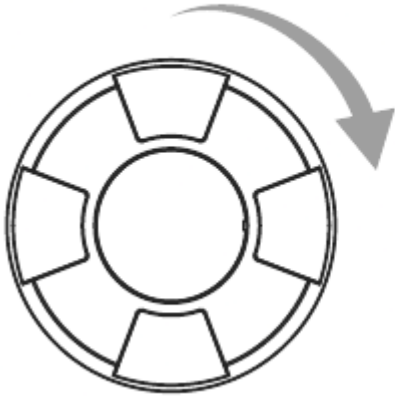

FM descendente

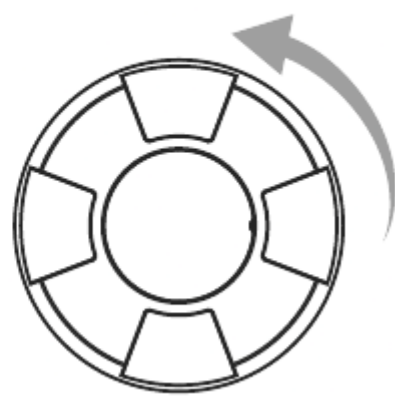

Mode Introduction

Regardless of the specific mode chosen, after being turned on, it can first connect to the mobile's Bluetooth and then choose the mode to operate. If a mode is selected and pairing and connection are successful, you can use Method II in 5.3 to re-enter the state of alternating red and blue lights flashing, and then search and connect via the mobile's Bluetooth; in this case, you need to click the power button twice to start the intercom for the first time.

6.1 Bluetooth Intercom Mode

Note: If it has been previously connected with another Bluetooth headset, please first delete the Bluetooth pairing record. After being turned on, it is by default in Bluetooth intercom mode, and in this mode, the device can only pair and intercom with another TK-X4 (or TK-X4SC) device.

Intercom Between Two TK-X4 Devices

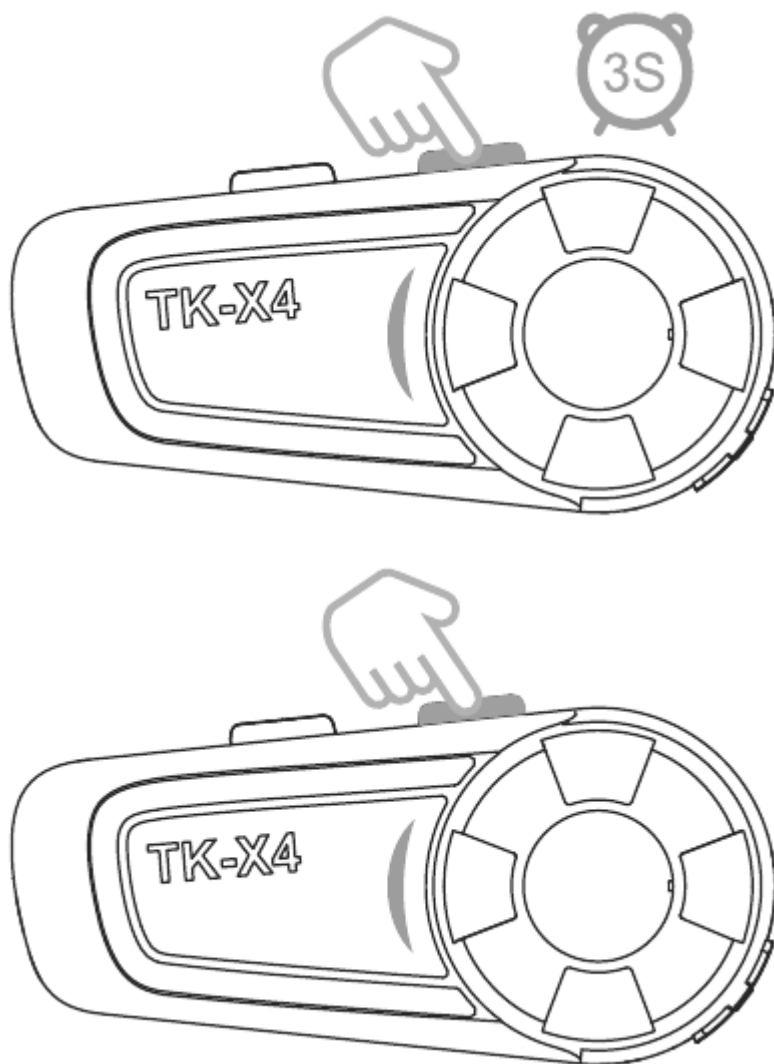

After turning on 2 TK-X4 devices, hold down the mode button for 3 seconds to enter pairing mode for intercom (the green light flashes rapidly), accompanied by the warning sound 'dendendenden'.

Click the mode button on one of the devices (accompanied by the warning sound 'Intercom Search') to pair. Once paired, both devices will have the green light flashing slowly accompanied by the warning sound 'Intercom Connected'. At this point, intercom can be started.

Intercom Disconnection

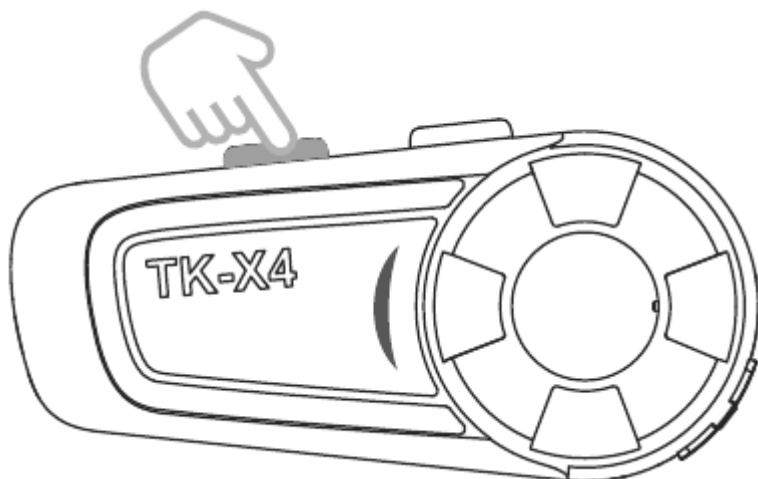

During intercom communication, click the power button, accompanied by the warning sound 'Intercom Disconnected'.

Intercom Reconnection

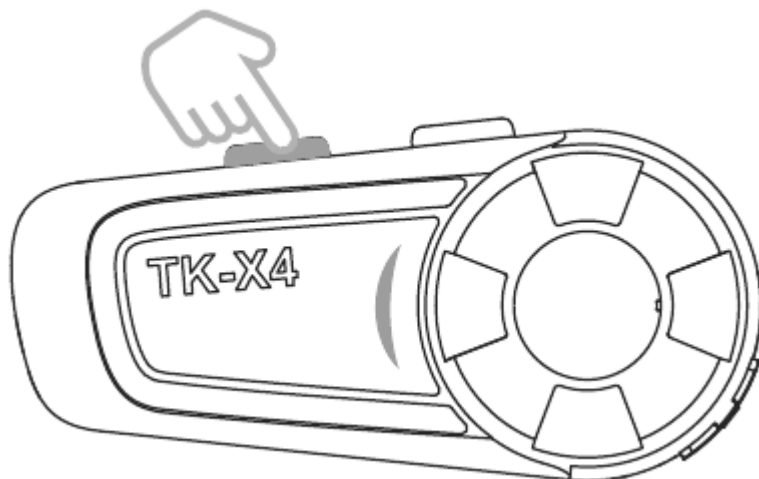

When the intercom is disconnected, click the power button, accompanied by the warning sound 'Intercom Connected'.

6.2 Bluetooth Group Intercom Mode

Note: To use Bluetooth group intercom mode, please first delete the TK-X4 Bluetooth pairing record.

One-Click Network Connection for 4 People

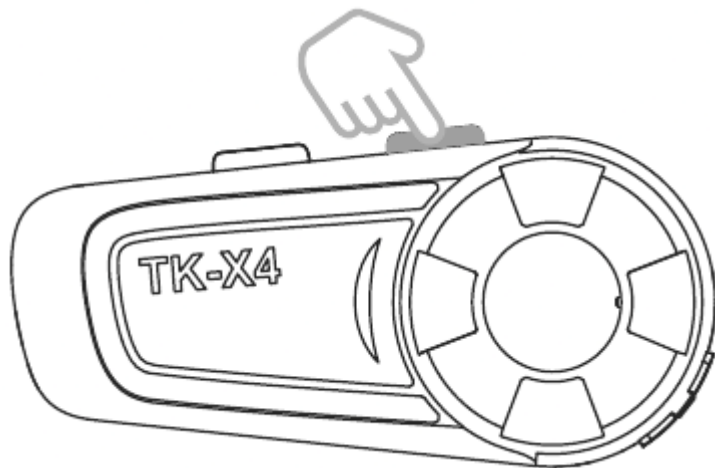

1. After turning on 4 TK-X4 devices, click the mode button to switch to Bluetooth group intercom mode (accompanied by the warning sound 'Bluetooth Group Intercom Mode' and the red light flashes twice).

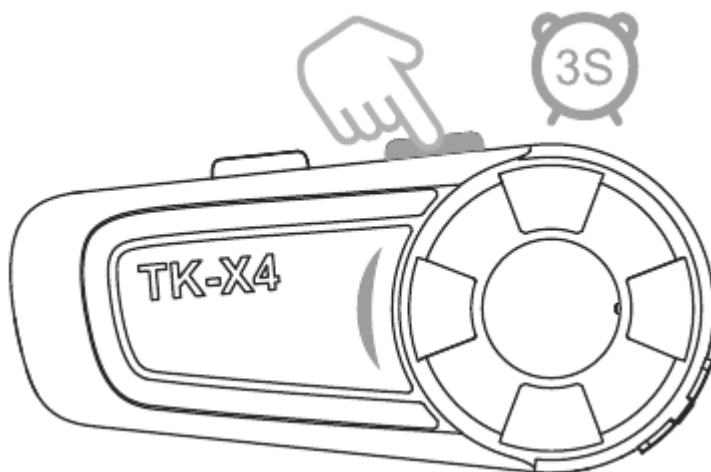

2. Hold down the mode button for 3 seconds to enter intercom pairing mode (the green light flashes rapidly), accompanied by the warning sound 'Dendendenden'.

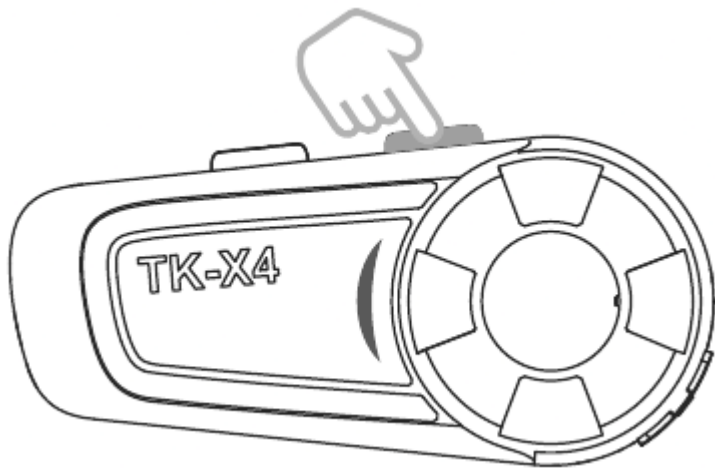

3. Click the mode button on one of the devices (accompanied by the warning reminder 'Intercom Search') to pair. The device that initiates the pairing first is unit 1. Unit 1 automatically connects to unit 2, and 2 to 3, and so on. Pairing is successful when 4 devices show a slowly flashing blue light (accompanied by the warning sound 'Di').

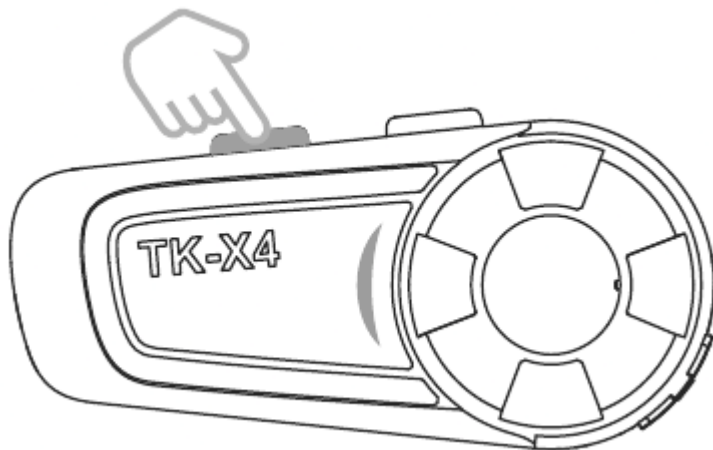

4. After successful pairing, click the power button on each device to start the intercom.

Intercom Disconnection

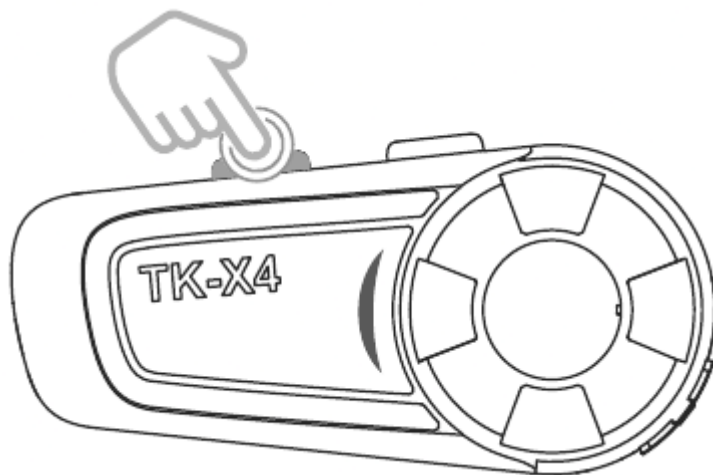

During the intercom communication, double click the power button, accompanied by the warning sound 'Dudu'.

Intercom Reconnection

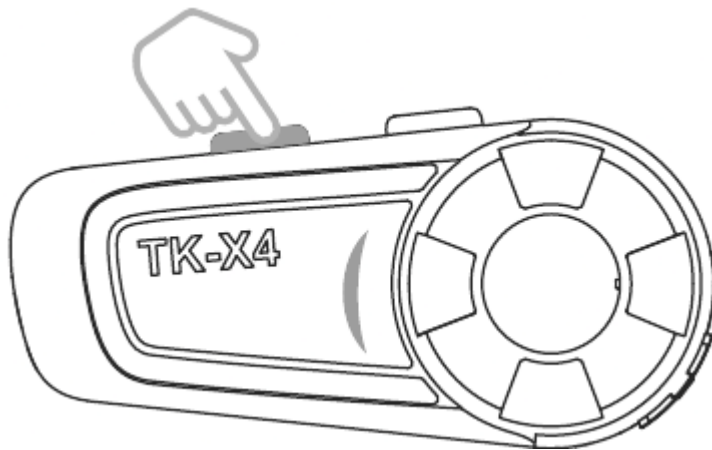

When the intercom is interrupted, click the power button, accompanied by the warning sound 'Di'.

Voice Number Announcement

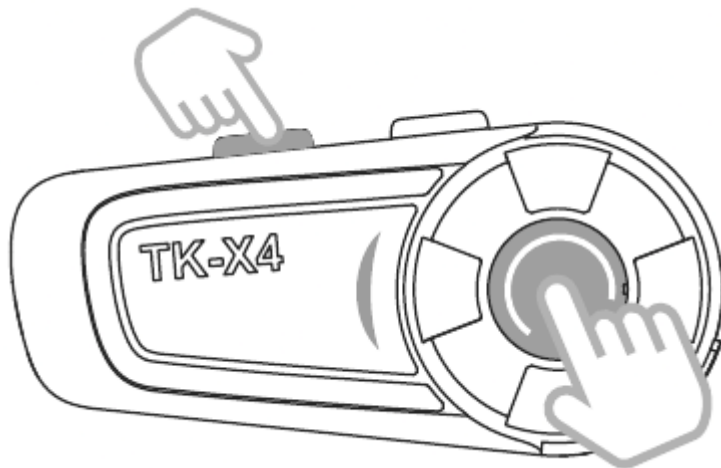

During the group intercom, click the power button and the phone button simultaneously to announce the unit number of the current device, for example: “This equipment is unit 1”. (In other modes, the current mode is announced with the same operation).

3-Person Group Intercom

If only 3 devices need to be paired, please follow the steps for one-click network connection for 4 people. When 3 devices are successfully paired, click the power button on all devices to start the intercom, and unit 3 will not search for unit 4.

6-Person Group Intercom

Please first follow the first 3 steps for one-click network connection for 4 people, then have units 4 and 5 enter the intercom pairing mode (the green light flashes quickly), and then click the mode button on unit 4 to pair with unit 5; after successful pairing, repeat the previous operations for units 5 and 6. After successful pairing of all units, click the power button on each device to start the intercom.

Note: The 6-person Bluetooth group intercom mode of TK-X4 constitutes a chain-type connection. If one device is disconnected from the intercom, it affects the connection of the devices ahead and behind it. For example, if unit 2 is disconnected, it affects the connection between unit 1 and units 3, 4, 5, 6; however, it does not affect the connection between unit 3 and units 4, 5, 6.

6.3 Music Sharing Mode

Note: If using the music sharing mode, please first remove the TK-X4 Bluetooth pairing record.

1. After turning on both TK-X4 devices, click the mode button to switch to music sharing mode (accompanied by the warning sound 'Music Sharing', and the red light flashes 3 times).

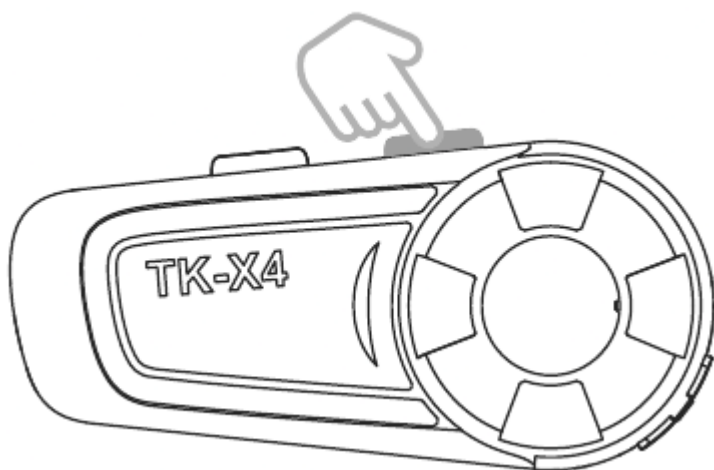

2. Press and hold the mode button for 3 seconds to enter pairing mode (the green light flashes quickly).

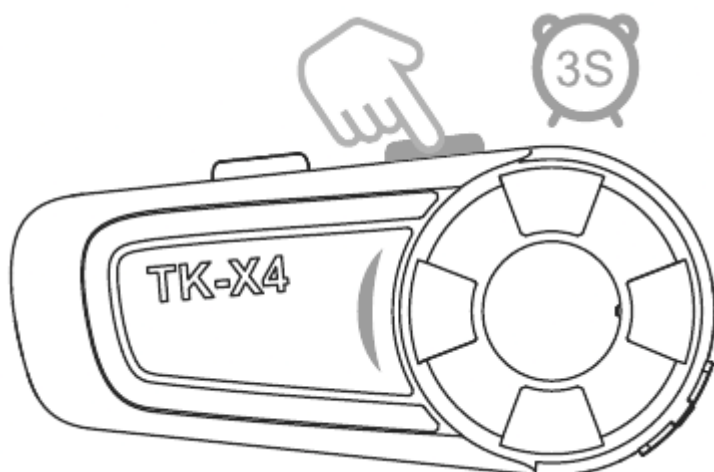

3. Click the mode button on one of the devices (accompanied by the warning sound 'Intercom Search') to start pairing. Once pairing is successful, you will hear the warning sound 'Di' and the blue light will flash slowly. Finally, connect to the mobile phone according to the method in section 5.3.

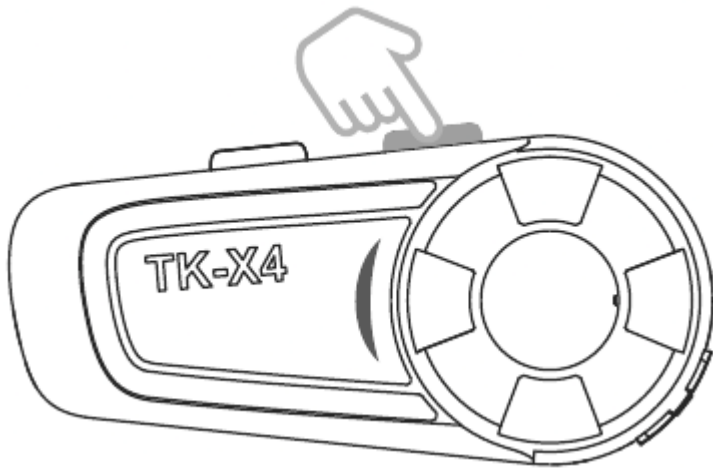

Note: The device that connects to the mobile phone first will have priority to share music with the other device, and both devices can control music changes and volume during sharing.

End Sharing

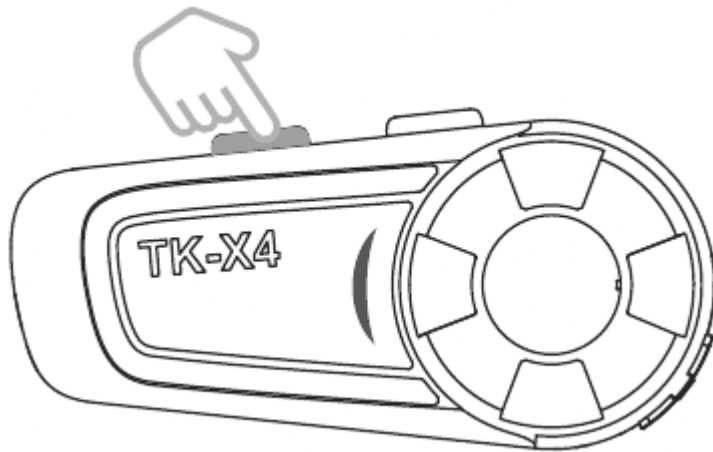

During sharing, click the power button on one of the devices.

Reconnection for Sharing

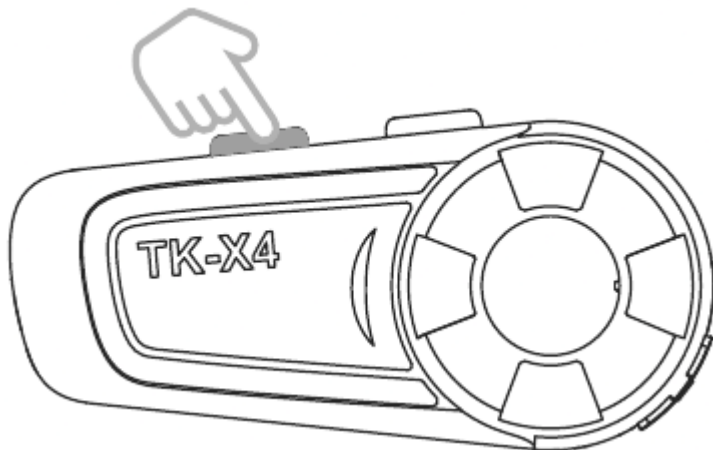

When sharing is disconnected, click the power button on one of the devices, and both devices will re-enter pairing state (the green light flashes quickly) and connect automatically. Once successful, the device that connects to the mobile phone first will have priority to share music with the other device.

6.4 Common Pairing Mode

Note: The common pairing mode allows pairing for intercommunication with a TK-X2 product of the same series, as well as with most Bluetooth headsets or Bluetooth intercoms on the market. To use this mode, please first remove the TK-X4 Bluetooth pairing record.

1. After turning on the TK-X4, click the mode button to switch to common pairing mode (accompanied by the warning sound 'Bluetooth Interconnection', and the red light flashes 4 times).

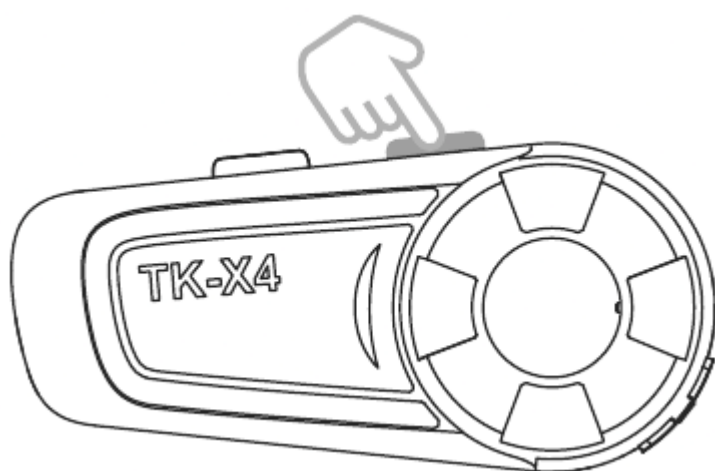

2. Press and hold the mode button for 3 seconds to enter pairing state (the green light flashes quickly).

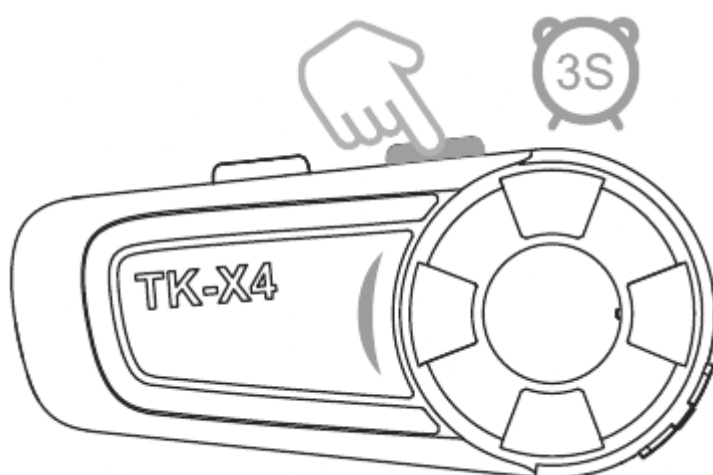

3. Turn on another Bluetooth headset or Bluetooth intercom and put it in pairing state. Then, click the mode button on the TK-X4 to start pairing (accompanied by the warning sound 'Intercom Search'). Once pairing is

successful, the green light flashes slowly accompanied by the warning sound 'Intercom Connected'.

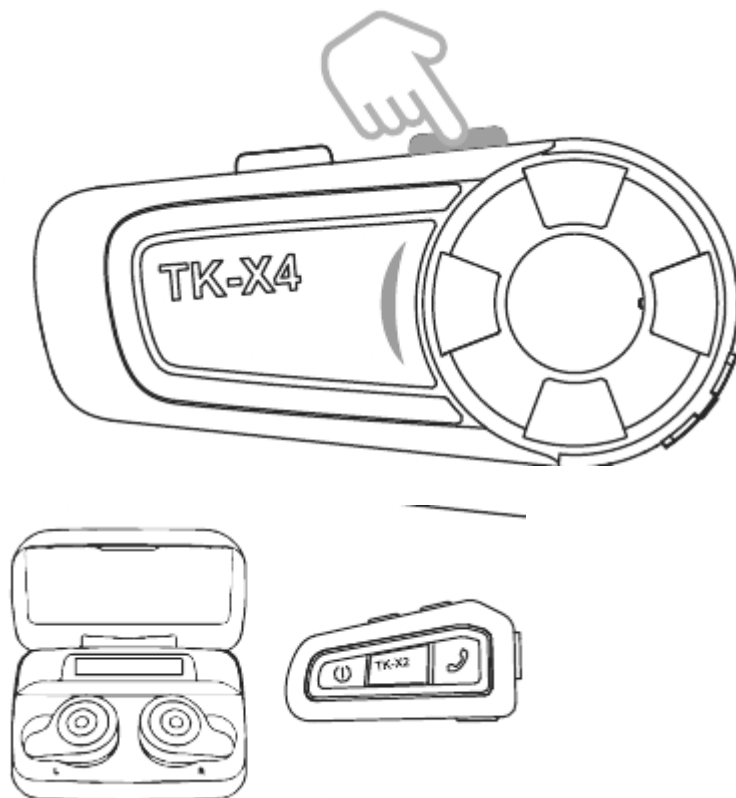

Note: Use the TK-X4 helmet Bluetooth headset to actively pair and connect with intercoms from other brands (except intercoms of the same brand), so that the TK-X4 can become the active unit and can disconnect or connect the intercom call through the button.

Disconnection

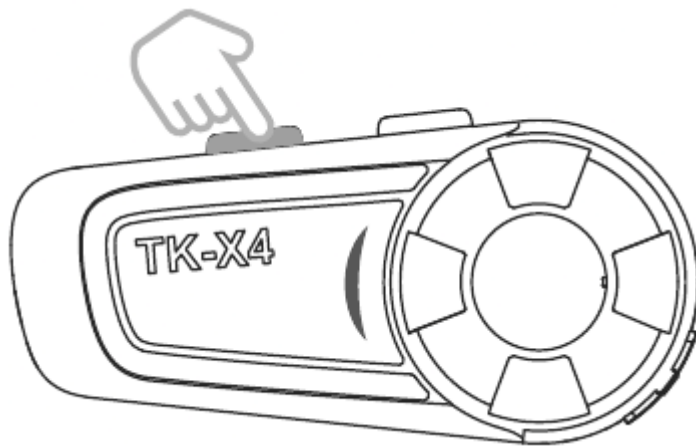

During intercommunication, click the power button, accompanied by the warning sound 'Intercom Disconnected'.

Reconnection

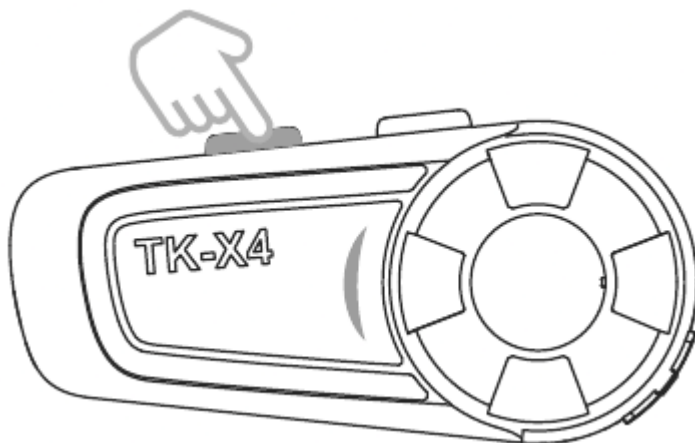

When intercommunication is disconnected, click the power button, accompanied by the warning sound 'Intercom Connected'.