

SHENZHEN ZEALOT **WIRELESS SPEAKER User** **Manual 2AFKR-S87**

Manualsum, simplified manuals

Table of Contents

- [ZEALOT Wireless Spaker User Manual](#)
 - [Warning](#)
 - [Packing Content](#)
 - [Power On](#)
 - [Wireless Connection](#)
 - [Mode Switch](#)
 - [Play](#)
 - [Light](#)
 - [Partyadd](#)
 - [Technical Specification](#)
 - [EQUALIZER](#)
 - [Charge](#)

ZEALOT Wireless Spaker User Manual

(2AFKR-S87)

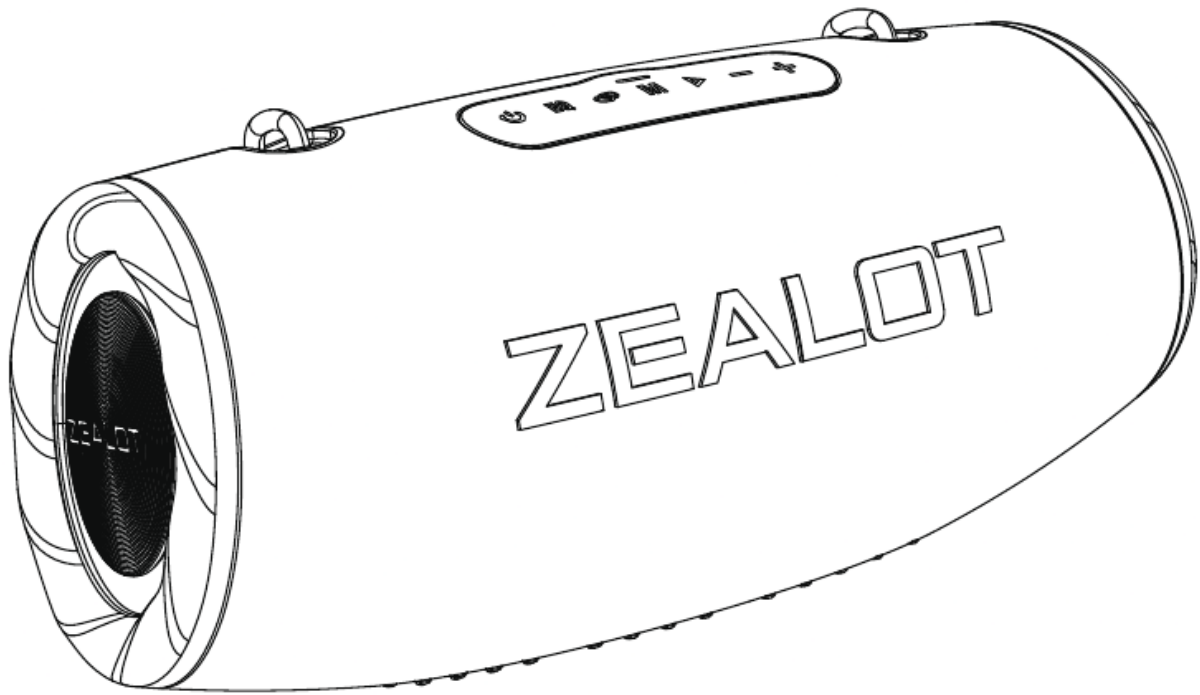

Warning

1. To ensure correct use and trouble-free operation, please read this user manual carefully first.
2. For the first use, it is recommended to fully charge it.
3. Please use and store the product at room temperature.
4. Do not expose the product to fire, high temperature, direct sunlight, etc.
5. Please keep the speaker volume moderate to avoid temporary or permanent hearing impairment.
6. Do not use organic solvents or other chemicals to clean the product.
7. Do not let small particles enter the product.
8. Do not disassemble the product or make any modifications to the product structure or any part thereof. If the battery is not replaced correctly, there will be an explosion accident, only the same battery type can be replaced.
9. The battery (battery pack) must not be exposed to such sunlight, fire or similar overheating conditions.
10. Do not throw and drop the product to avoid damage.

Packing Content

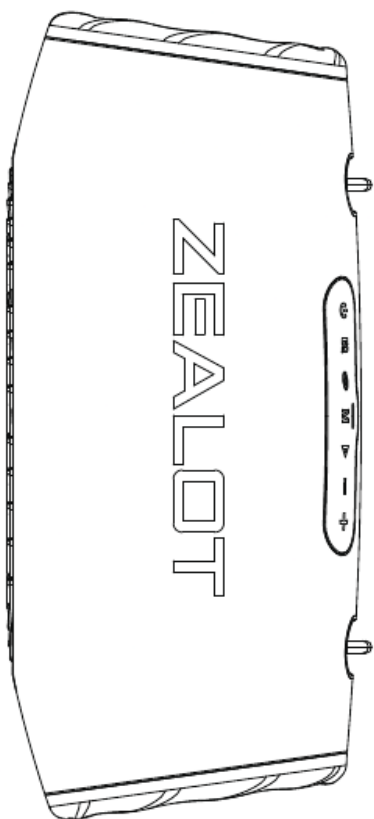

USB-C

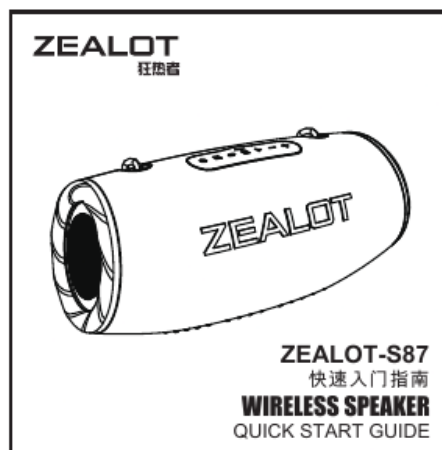
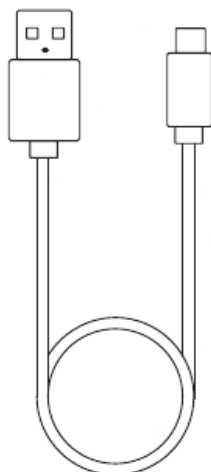

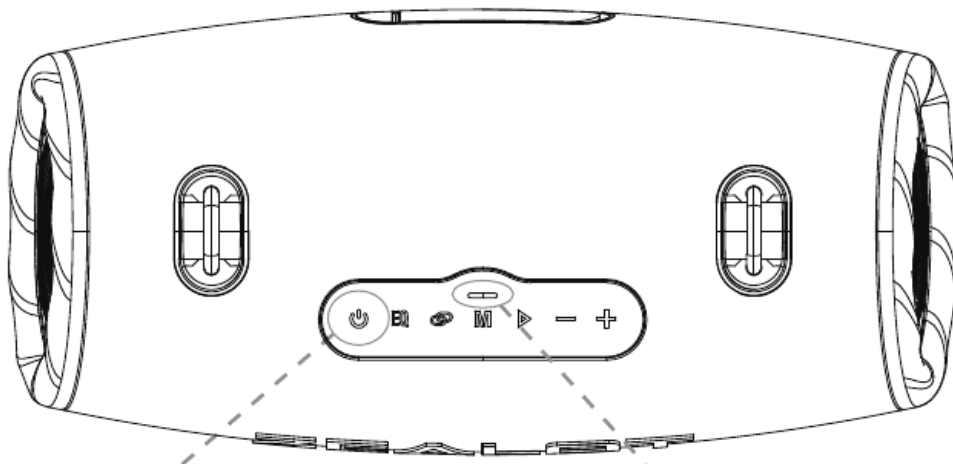

Power On



> 3 ⌚

ON/OFF
开关机

Battery 电量

80%-100%	Green light is on 绿灯亮	
40%-70%	Yellow light is on 黄灯亮	
≤ 30%	Red light is on 红灯亮	

Wireless Connection

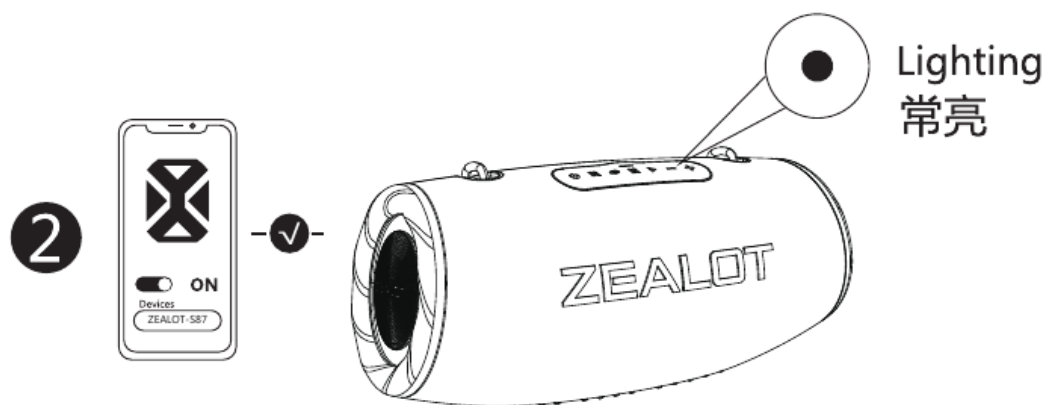
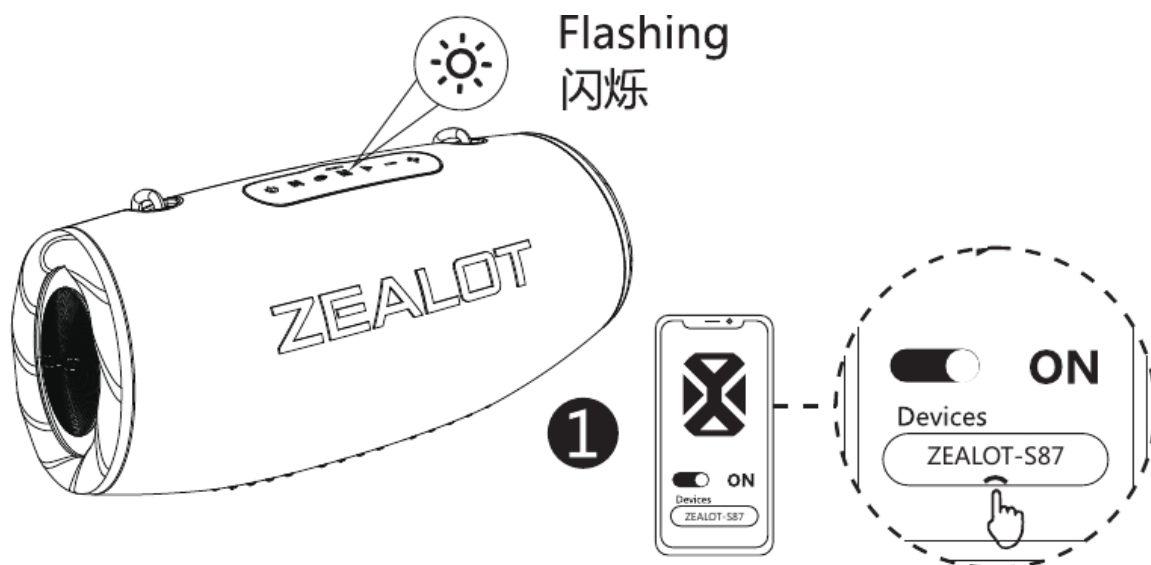

Mode Switch

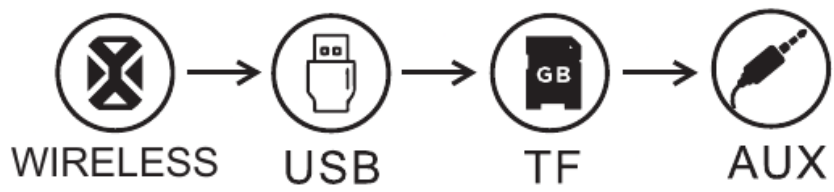
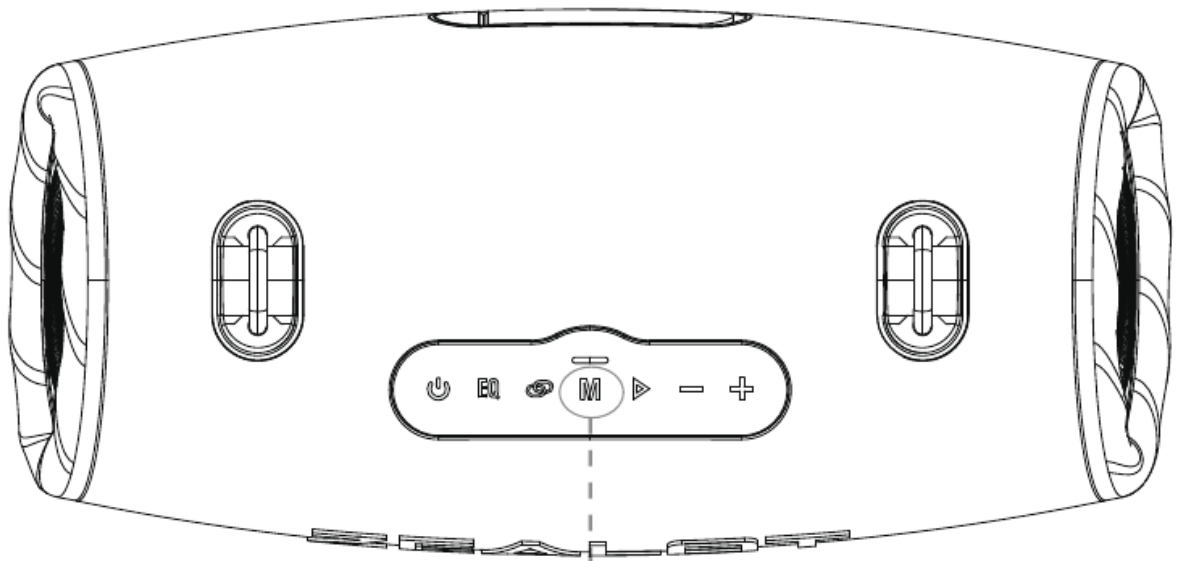

Play

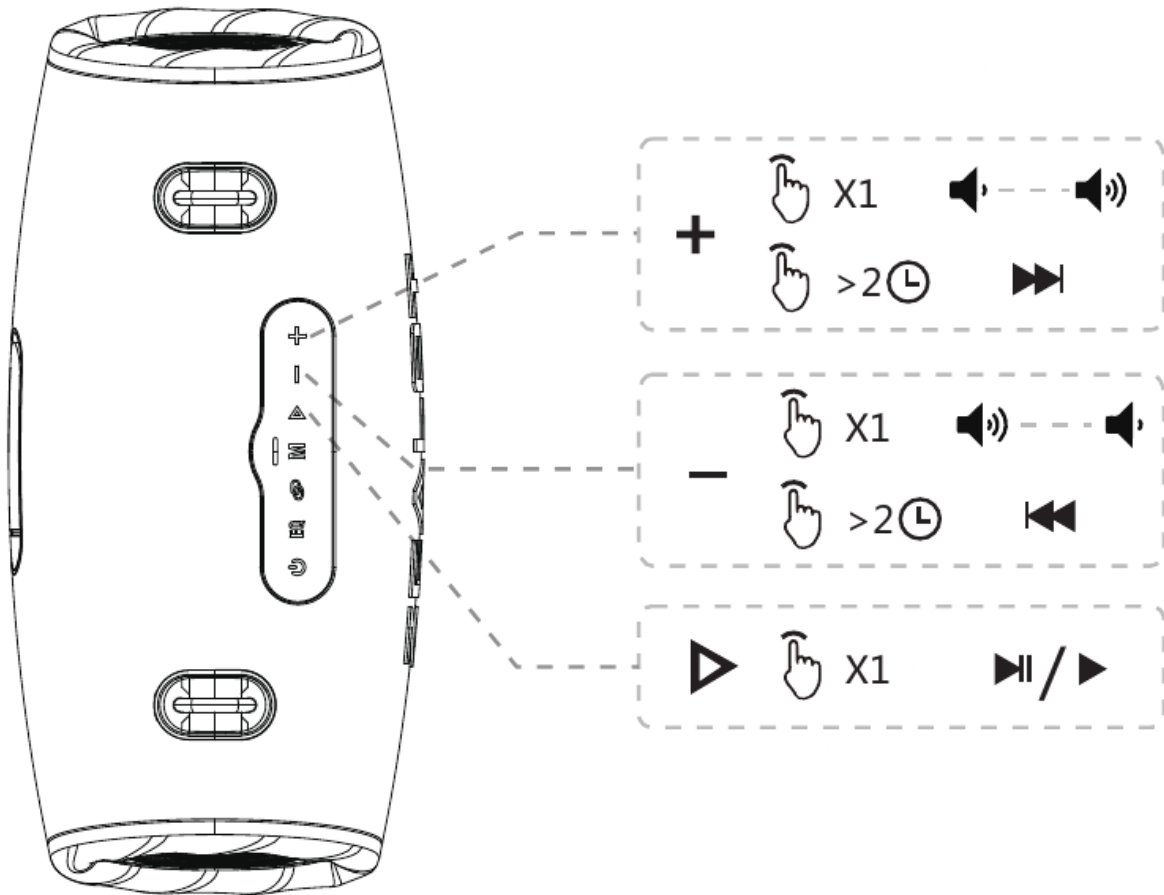

Light

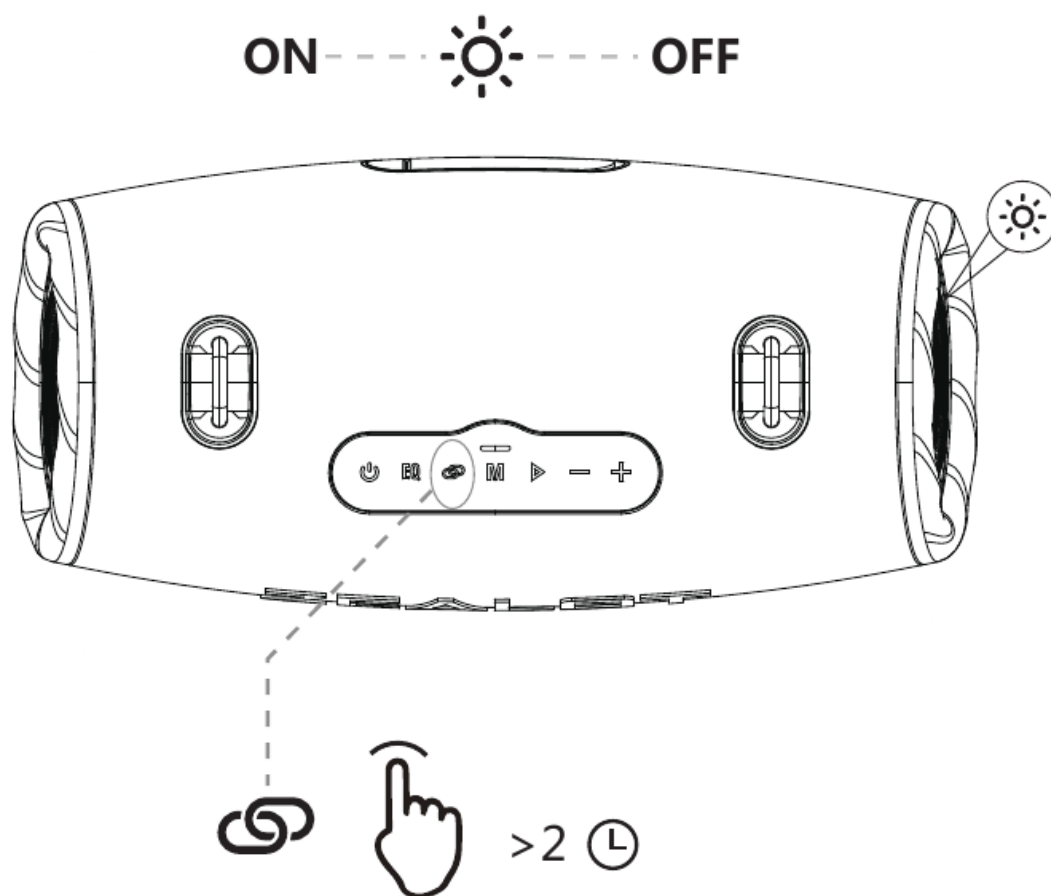

Long press to turn on / off the light
长按开关灯

Partyadd

When both machines are turned on and the distance is with 1 m, click on the button of both machines to connect each other. After the first connection is successful and the subsequent connection will be automatic.

1. Turn on the Wireless of your phone and cancel the " ZEALOT-S87 " of the Wireless list.
2. Turn on the two speakers and keep their distance in the range of 1 m.
3. Click the button of both machines, there will be a prompt tone, it means the click is successful, and if you hear the prompt tone again, it means the couplet is successful.
4. Turn on the Wireless again, waiting for the signal of the device (ZEALOT-S87) appears and connect it.
5. Play the music and test whether two speakers are playing together at the same time.

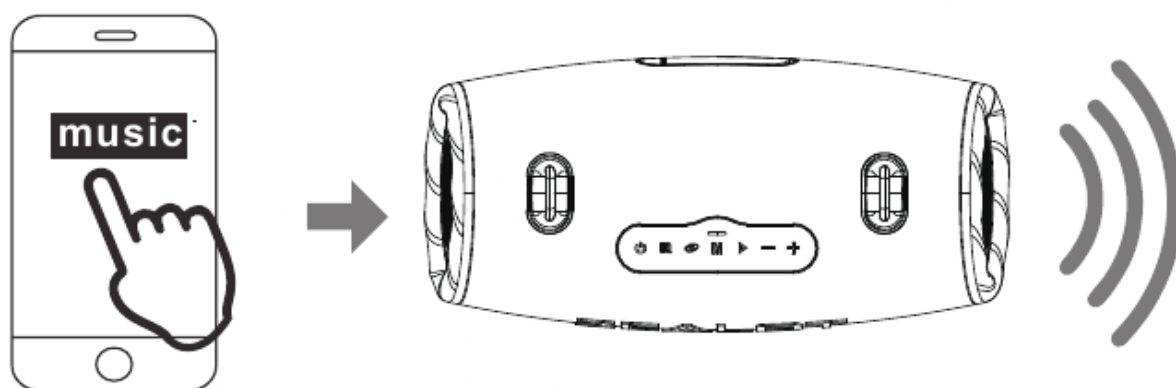
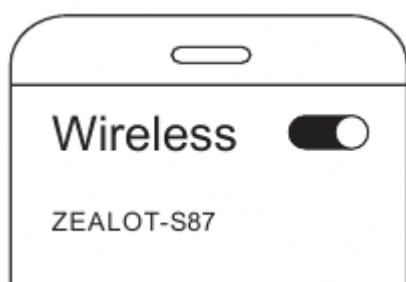
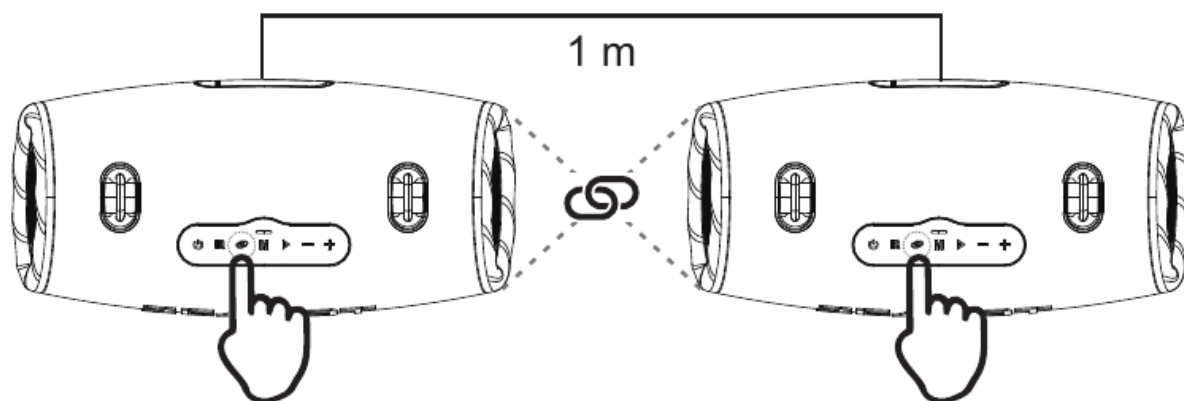



Technical Specification

Wireless version	V5.2
Charging voltage	DC5V 2A

Working voltage	7.4V
Transmission distance	10m
Frequency range	20Hz-20KHz
Speaker	®76mm*2+®38mm*2
SNR	290dB
Distortion	<1%
Weight	2.8kg
Size	321*151*145mm

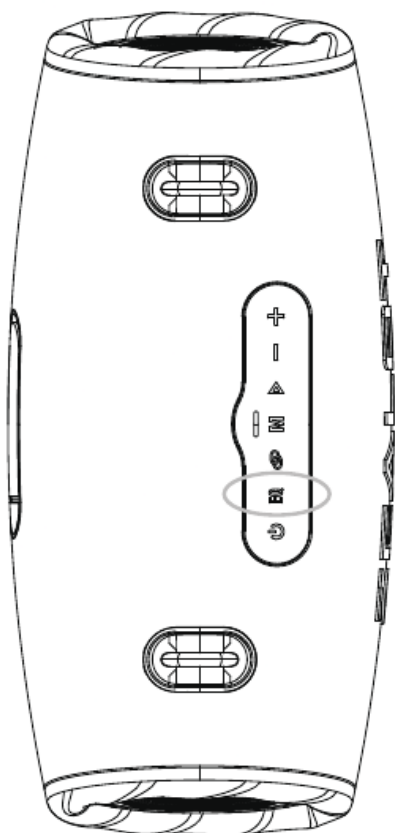
EQUALIZER



EQ  x1 Bass / 重低音
(Green light is on 绿灯亮)



EQ  x1 Vocal / 人声
(Orange light is on 橙灯亮)



EQ  x1 Normal / 正常音

Charge

