

RENPHO Massage Gun User Manual

Manualsum, simplified manuals

Table of Contents

- [RENPHO Massage Gun User Manual](#)
 - [IMPORTANT SAFETY INSTRUCTIONS](#)
 - [WHAT'S IN THE BOX](#)
 - [SPECIFICATIONS](#)
 - [PRODUCT OVERVIEW](#)
 - [MESSAGE HEAD ATTACHMENTS](#)
 - [CHARGING](#)
 - [ATTACHING THE MESSAGE HEAD](#)
 - [USING THE PRODUCT](#)
 - [APP GUIDE](#)
 - [CLEANING AND MAINTENANCE](#)
 - [TROUBLESHOOTING GUIDE](#)
 - [WARRANTY POLICY](#)
 - [CUSTOMER SERVICE](#)

RENPHO Massage Gun User Manual

RENPHO Massage Gun User Manual

Sichuan Qianli-beoka Medical Technology Massage Gun User Guide

FCC id: [2A55F-RWVG08](#)

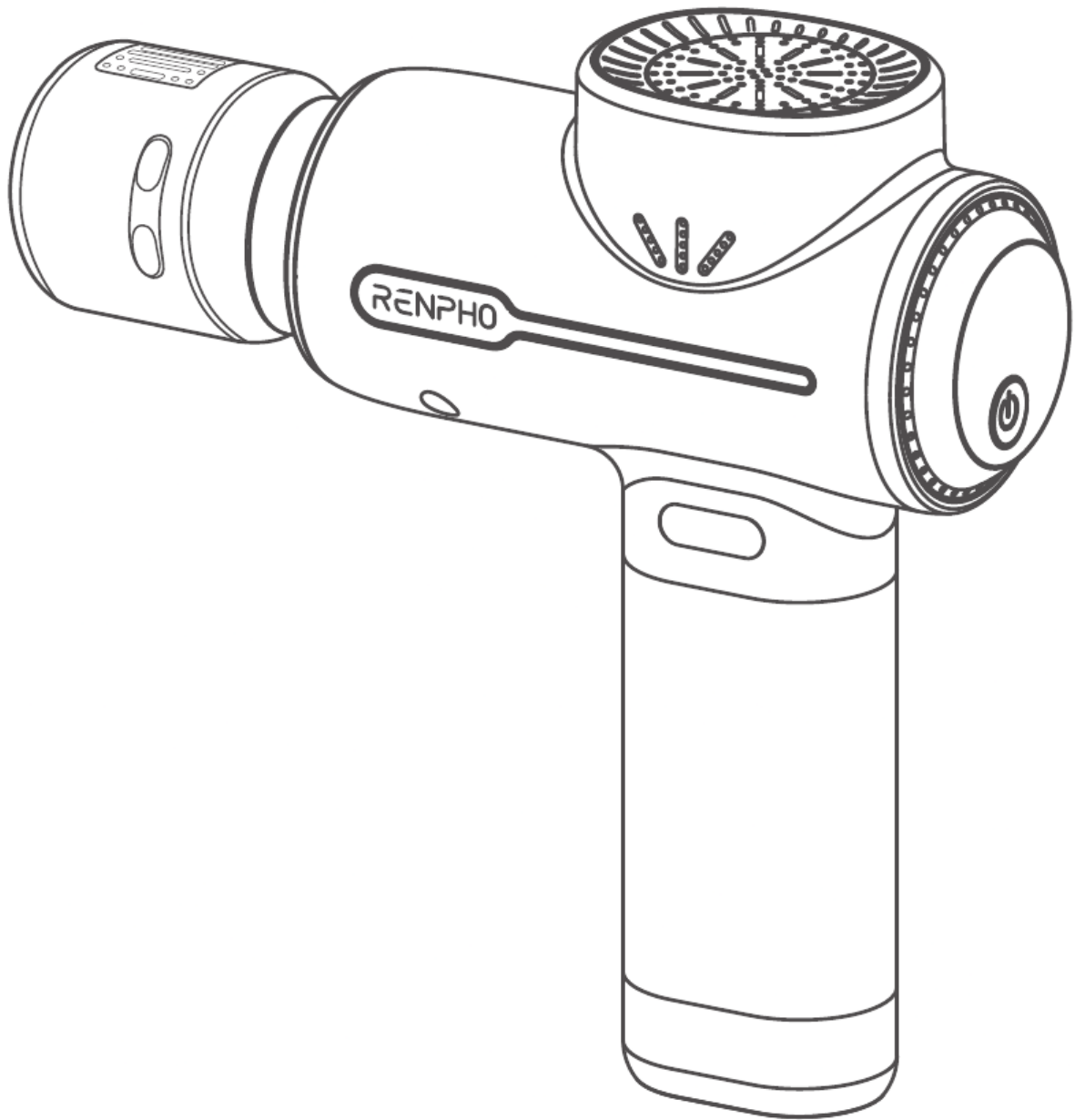

RENPHO

Smart Health Simplified

Model: R-WMGO08

Massage Gun

[Manualsum](#)

IMPORTANT SAFETY INSTRUCTIONS

READ ALL INSTRUCTIONS CAREFULLY BEFORE USING.

When using this device, the following basic precautions should be always followed:

1. The device is intended for household use only and not intended for medical use.
2. This device can be used by children aged 8 years and above and by persons with reduced physical, sensory or cognitive capabilities or lack of experience and knowledge if they have been given supervision or instructions concerning the use of the device in a safe way and understand the hazards involved.
3. Children should not play with the device. Cleaning and user maintenance should not be made by children.

DANGER - To reduce the risk of electric shock:

1. Do not attempt to retrieve the device if it falls into water.
2. Do not use while bathing or in a shower.
3. Do not use the device with wet hands.
4. Do not place or store the device in areas where it may fall or be pulled into a tub or sink. Do not place in or drop into water or other liquid.

WARNING - To reduce the risk of fire, electric shock, or injury to persons:

1. Please consult your doctor before using if you are a user of the following persons:
 - Children under 8
 - Pregnant women
 - Persons with blood stasis
 - Persons with fractures
 - Persons with heart disease, a pacemaker, defibrillator, or metal contents in the body
 - If you have experienced joint surgery within 90 days, do not use the device on your body within 3 inches of the surgical site. If you feel unwell or have any unusual discomfort, please stop using the device immediately.
2. Do not use the massage gun on
 - Sensitive skin, swollen or inflamed areas, in areas where there is poor circulation, where skin eruptions are present, or in the area of unexplained abdominal pain
 - Head, face, cervical vertebrae, body bones, varicose veins, tumor site, throat area, any possible fracture site, positions close to the bony areas: the humerus, the back of the foot, the back of the hand, etc
 - Genital area (Do not use this device for sexual purposes. It is a powerful massaging device and may cause severe bodily harm.)

- Unconscious or sleeping persons
3. Do not operate under a blanket or pillow. Excessive heating may occur and cause fire, electric shock, or injury to persons.
 4. Never operate the device with the air openings blocked. Keep the air openings free of lint, hair, etc.
 5. Close supervision is necessary when this device is used by, on or near children, invalids, and disabled persons.
 6. Use this device only for its intended use as described in this manual. Do not use attachments not recommended by the manufacturer.
 7. Never operate this device if it is not working properly, has been damaged, or dropped into water.
 8. Never drop or insert any object into any opening.
 9. Do not operate in the areas where aerosol (spray) products are being used or where oxygen is being administered.
 10. Do not keep the device near a magnetic field or in the areas where it can be affected by a magnetic field as it may cause batteries to discharge.
 11. Avoid touching the gap between the massage head and body with your finger or hair to avoid pinching.
 12. Keep the device away from heat and avoid using it in places where the surrounding temperature is relatively hot.
 13. Do not drop, apply excessive force or heavy weight over the device to avoid malfunction and/or damage.
 14. If a high temperature or foul odor occurs while using the device, stop using the device immediately.
 15. Do not use the device in close proximity to long hair, loose clothing or jewelry.
 16. Avoid applying excessive pressure on the massage head and refrain from massaging the same area continuously for an extended period of time.
 17. The device is equipped with a heating and cooling massage head. Persons sensitive to heat or cold must use it with caution.

About the Battery

1. Warning Chemical Exposure: If the battery pack leaks, do not allow the liquid to contact the skin or eyes. If contact has been made, wash the affected area with copious amounts of water and seek medical advice.
2. Battery life may vary by application and/or operating conditions. If the device is not in use for a long period of time, please keep it powered off and charge it once a month to prolong its lifespan.

3. Do not expose the device or battery to excessive temperatures.
4. Be aware of the risk of terminals of the battery-operated device or battery being short-circuited by metal objects.
5. This device contains batteries that are non-replaceable. When the batteries are at end of life, the device shall be properly disposed of. Do not throw it into the fire or heat it. The device should be placed in a sealed plastic bag and safely disposed of in accordance with local environmental regulations.

SAVE THESE INSTRUCTIONS

WHAT'S IN THE BOX

- 1x Massage Gun
- 5 x Massage Head
- 1x USB-C Charging Cable
- 2x Rubber Sleeve
- 1x Travel Case
- 1x User Manual

SPECIFICATIONS

- **Product Name:** Massage Gun
- **Model:** R-WMG08
- **Input:** 5V = 2A
- **Battery Voltage:** DC 7.4V
- **Battery Capacity:** 2000mAh 14.8Wh
- **Amplitude:** 9mm
- **Speed:** 1800-2800r/min
- **Charging Time:** about 1.5H
- **Auto-off Timer:** 10min
- **Dimension:** 7.3×5.7×2.3in/186x147x60mm
- **Weight:** 1.5lb/6769g

Environmental Conditions:

- **Temperature:** 41°F-95°F/5 °C - 35°C
- **Relative Humidity:** =90%;
- **Atmospheric Pressure:** 70kPa-106kPa

PRODUCT OVERVIEW

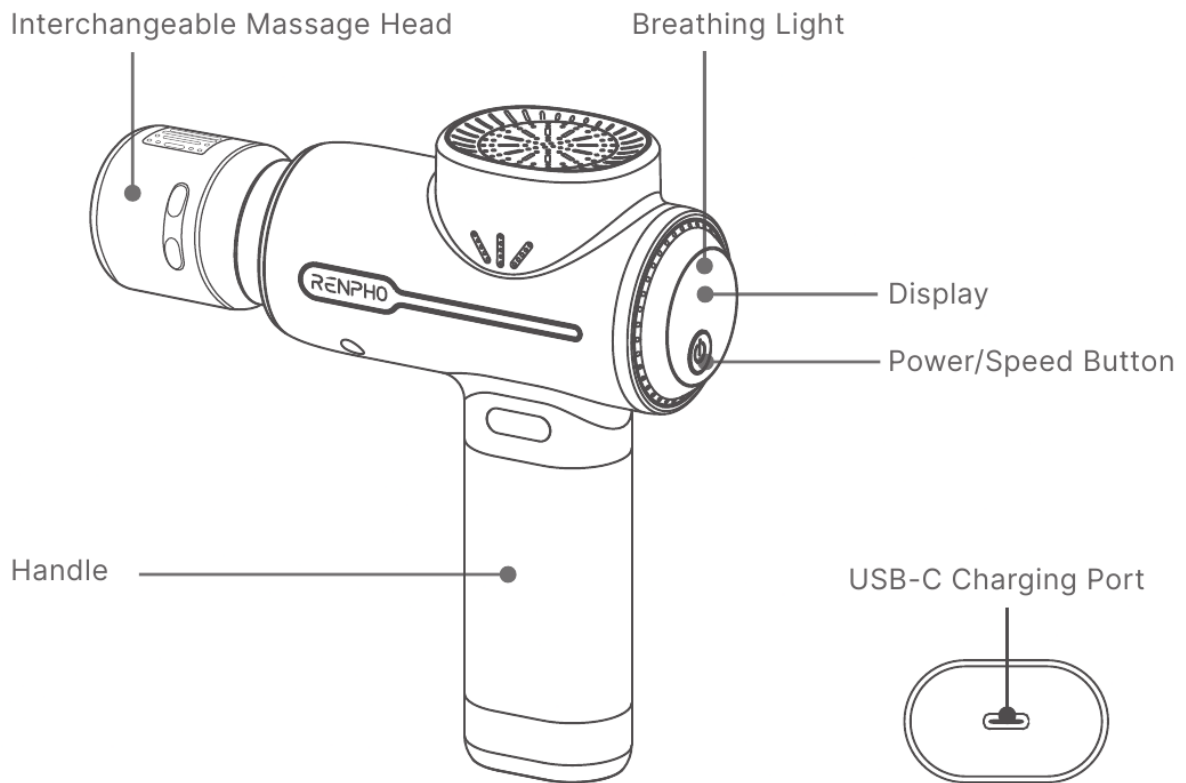

RENPHO Massage Gun User Manual

MESSAGE HEAD ATTACHMENTS



Ball head

For large muscle groups like quads, glutes, extreme muscles, and joint soreness.



Crescent head

For superficial muscles like brachioradialis and extensor digitorum.



U-shaped head

For spine, neck and Achilles tendon.



Heating head

For all parts of the body.



Bullet head

For joints, deep tissues, trigger points and small muscle areas like feet and wrist.



Rubber Sleeve

Each massage head is pre-installed with a rubber sleeve. If it is damaged, replace with a spare one.

TIP: DO NOT use on your head.

CHARGING

Fully charge the device before using it for the first time.

To charge, plug the provided USB-C charging cable to the unit's charging interface and into the mobile power source or mobile charger (not included). Ensure the input should be DC 5V, 1A/2A.

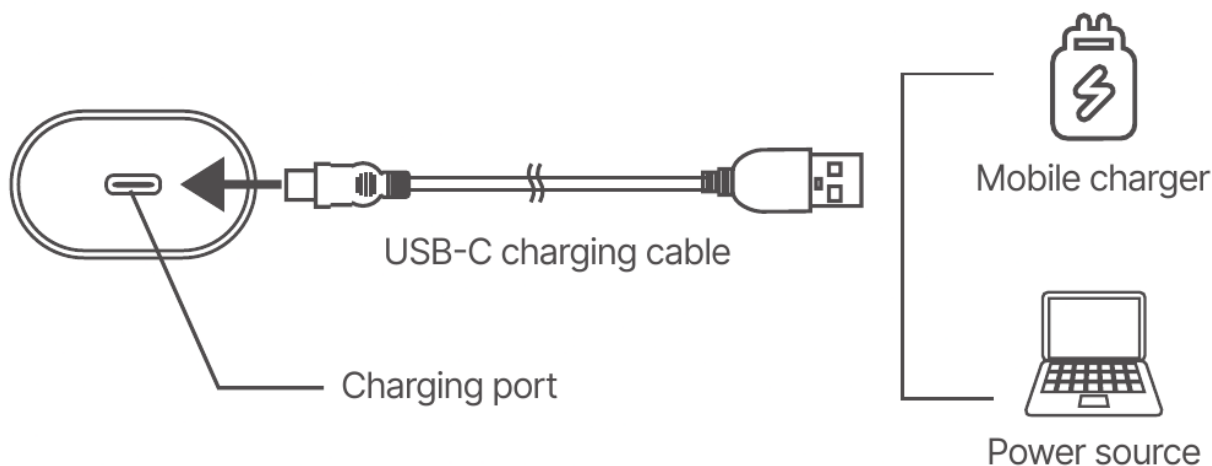

Status

Display

Low Battery

Flashes red "  "

Normal charging Shows current battery level

Fast charging

Shows "  " and current battery level

Note: The device cannot be turned on while charging.



ATTACHING THE MESSAGE HEAD

Select the desired message head and connect to the device properly by fully inserting the joint into the slot. Ensure the device is turned off when switching the message head.

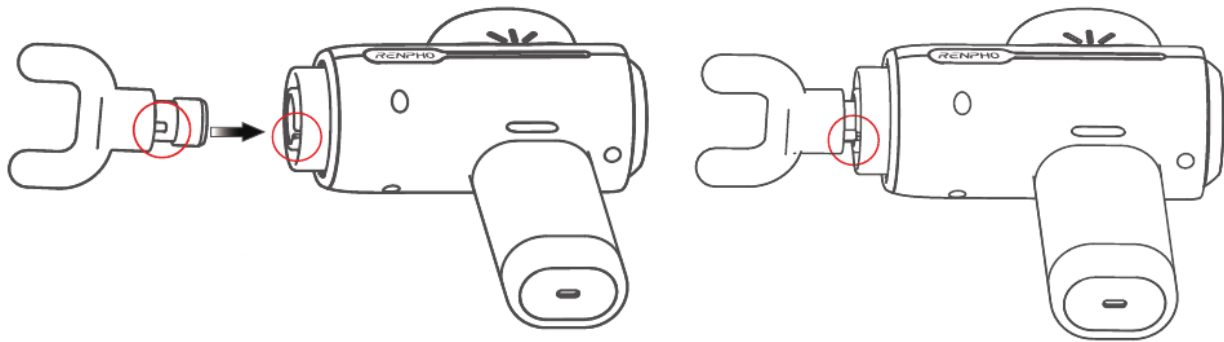
Note: The installation of the U-shaped head should be positioned. When the buckle is inserted into the slot, it means the installation is in place. Otherwise, there will be a risk of falling off while in use.



USING THE PRODUCT

-  **a.** Press and hold " " for 2s to turn on the device. The indicator light will turn on and the display will show the current battery level and then "LO".
-  **b.** After power on, press" " to cycle through speed levels: L1/L2/L3/L4/L5 (RPM: 1800/2050/2300/2500/2800r/min).
-  **c.** Press and hold " " for 2s again to turn off the device. The indicator light and the display will turn off.

Note:

- The device will enter standby status if left idle for 120s after power on.
- Auto-off function: The device shuts off automatically after 10 minutes of continuous use.
- Locked-motor protection: If you apply excessive pressure on the device during your session, the device will stall to prevent injury or bruising.
- It is recommended to start every massage session with minimal intensity before you get used to it. Do not use for more than 30 minutes at a time.

Breathing Light Instructions

Status

Normal operation

A little much pressure applied

Breathing Light

Blue

Orange

[Manualsum](#)

Stall warning: Excessive pressure applied Red

Charging Flashes green slowly when battery level < 20%

Fully charged Off

APP GUIDE

Step 1: Download the App Search and download the “Renpho Health” App from Apple App Store / Google Play or scan the QR code to download the Renpho Health App.



RENPHO Massage Gun User Manual

Note: Due to continuous updates and improvements, the “Renpho Health” App may appear slightly different.

*Apple and the Apple Logo trademarks of Apple Inc., registered in the U.S. and other countries. Google Play is a trademark of Google LLC.

Step 2: Log in/Sign up

- **a.** Log in directly with an existing RENPHO App account.
- **b.** If you don't have any RENPHO App account, tap “Sign up”. Register a new account of Renpho Health App using your email address and complete your profile information.



Step 3: Add Device

* Enable Bluetooth on your smartphone before adding the device.

- Method 1:

- a. Press and hold the Power button for 2s to turn on the device.
- b. A window will pop up on the phone screen and tap "Connect".

- Method 2:

- a. Tap "+" on the top right corner of the "Home" page to pair manually.
- b. Select "Massage" and tap "Massage gun".
- c. A window will pop up on the phone screen and tap "+".

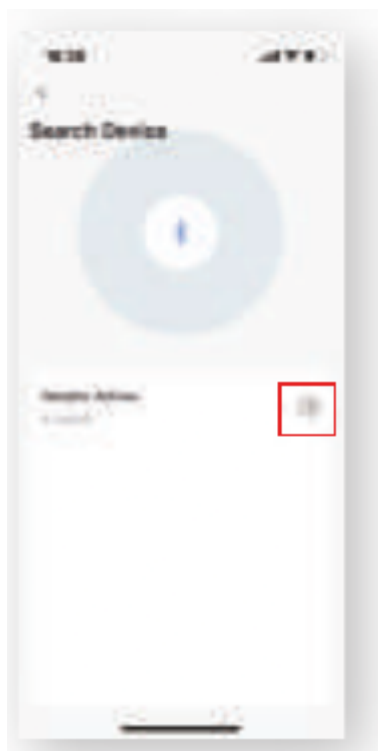

Note: If the device is connected to the App and left idle, it will automatically shut down in 2 minutes.

Step 4: Message

- **Method 1:** Message in free mode

- **a.** After a successful connection, you will enter the “Free mode” page.

- **b.** If you choose “Manual” mode (Default), you can choose the speed levels among level 1-5 manually to get your personalized massage.
- **c.** If you choose “Auto” mode, the device will automatically increase the

speed by 1 gear every 30 seconds. Tap  to reset the time.



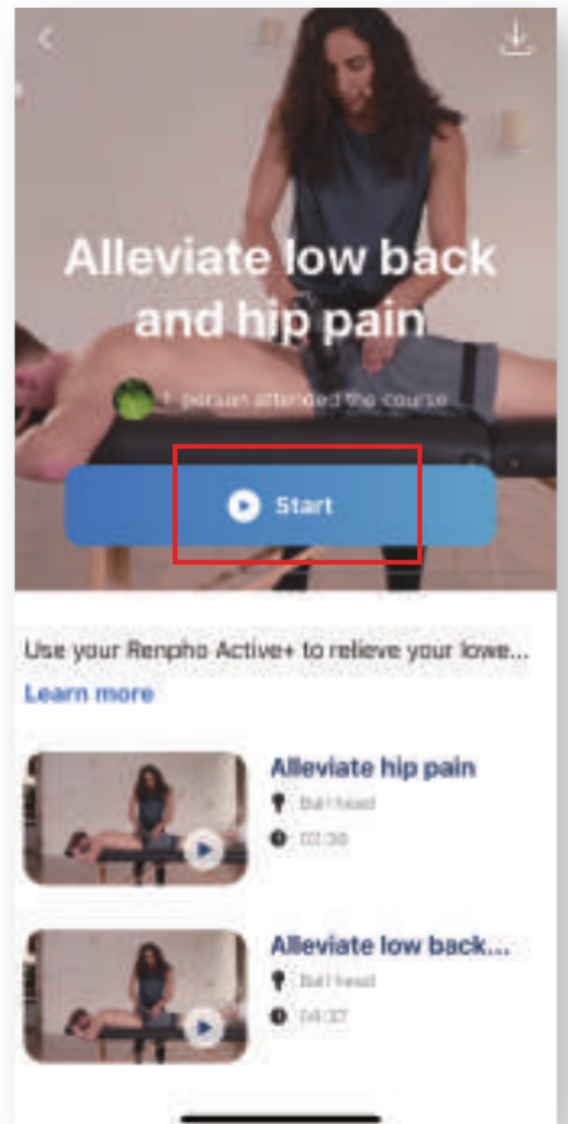
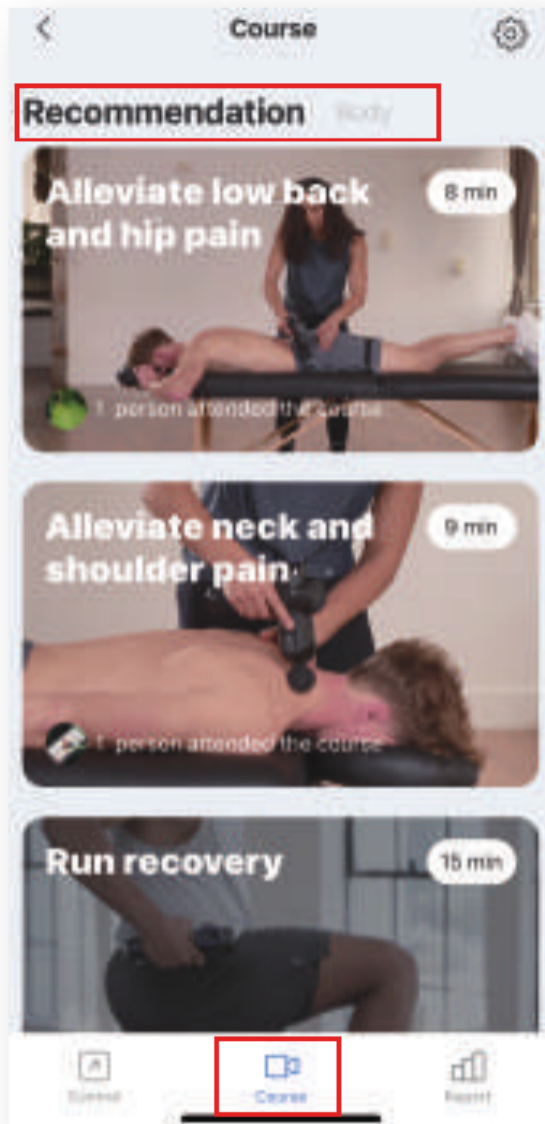

-Method 2: Choose the video course

- **a.** Tap “Course” and choose “Recommendation” for specific session or choose “Body” for specific muscle group massage.
- **b.** Choose your preferred course. Each session consists of corresponding videos course(s) with tips on which massage head to use and duration.
- **c.** Tap “Start” to follow it to massage.



* When the video is playing, you can tap it for additional settings.

1) Tap  to pause the video or choose to exit/continue the video.

2) Tap  to freely choose another course.

3) Tap Auto  to switch between Auto mode (Default) and Manual mode.

4) Tap  to turn on/off the background music or adjust the music volume.

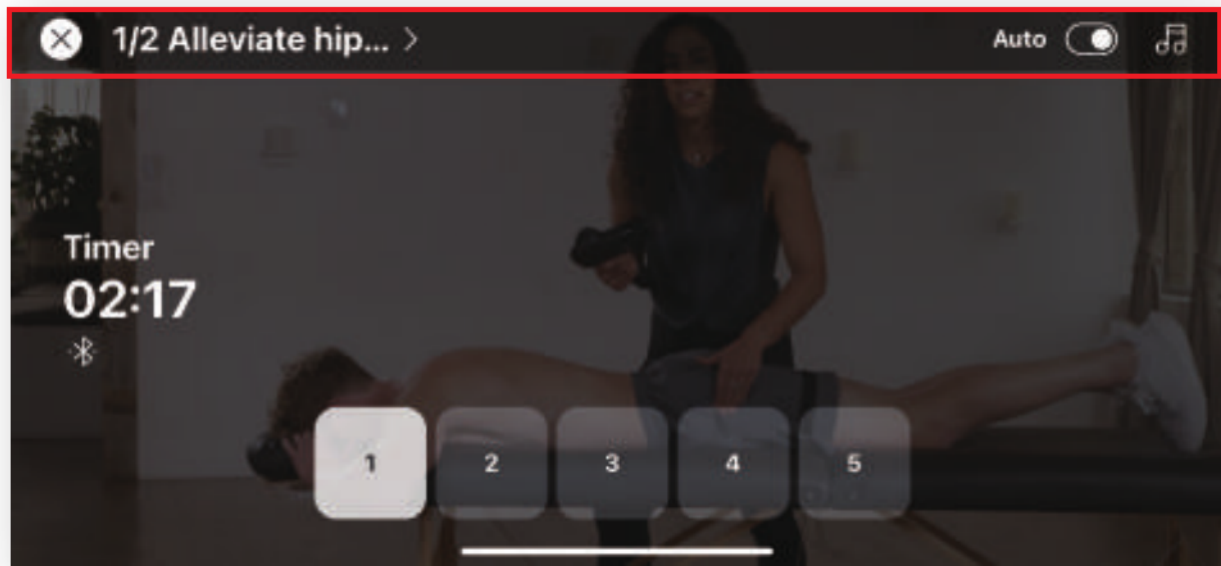

CLEANING AND MAINTENANCE

1. Turn off the device prior to cleaning. Use a soft towel or cloth to wipe the outer surfaces clean.
2. Do not attempt to disassemble or repair the device. The device does not contain user-serviceable parts.
3. Place the device in a cool, dry place when not in use.

TROUBLESHOOTING GUIDE

Problem	Cause	Solution
The device cannot be turned on.	Short press the Power button. Battery runs out.	Press and hold the Power button for 2s to turn on the device. Charge the device.
The device stops working suddenly.	Auto-off timer: The device automatically shuts off after 10 minutes of continuous use. Battery runs out.	Restart the device. Charge the device.
E1	The motor is locked.	Restart the device.
E2	The device is overheating.	Wait for the device to cool down before restarting it.
E3	The Power button is pressed while charging.	Do not turn on the device while charging.
Bluetooth connection fails.	Bluetooth on the smartphone is not enabled.	Enable Bluetooth on the smartphone.

The massage gun is connected by another mobile device.

Unbind the massage gun on another mobile device.

WARRANTY POLICY

Your RENPHO product purchase is covered by a one year limited manufacturer warranty from the date of delivery. For warranty terms and conditions, please visit: <https://renpho.com/pages/warranty-terms-and-conditions>

Note: Product registration is not required for the warranty. If you choose not to register your product, it will not diminish the product warranty.

CUSTOMER SERVICE

Please feel free to contact us if you have any questions or concerns. RENPHO Customer Service Team guarantees a quick response and hassle-free solutions to any issue you may have within business hours.



Tel: +1(844) 417 0149 (US&CA)

Monday-Friday 9:00AM-4:30PM

1800 MY RENPHO (1800 69 7367) (AU ONLY)

Monday-Friday 9:00AM-6:00PM (AEST)



Email: support@renpho.com (US&CA)

support-au@renpho.com (AU)

- For defective products or the return of items, please contact us with your order number within the specified warranty period. DO NOT dispose of any product parts as they may be required for inspection/repair.

Made in China

RENPHO Massage Gun User Manual

[Manualsum](#)